



---

# SPM Training Notebook

**004-130-000 (standard)**  
**004-130-100 (cleanroom)**

Copyright © 2003 Veeco Instruments Inc.  
All rights reserved.

## Document Revision History: SPM Training Notebook

Revision	Date	Section(s) Affected	Reference	Approval
Rev. E	10/27/2003	Content and Format Update	N/A	C. Kowalski
Rev. D	08/05/2003	Overall Content and Format Update	N/A	L. Burrows
Rev. C	07/30/2003	Content Update	N/A	L. Burrows
Rev. B	08/01/1998	Format Update	N/A	C. Fitzgerald
Rev. A	05/09/1997	Initial Release	N/A	J. Thornton

---

**Notices:** The information in this document is subject to change without notice. NO WARRANTY OF ANY KIND IS MADE WITH REGARD TO THIS MATERIAL, INCLUDING, BUT NOT LIMITED TO, THE IMPLIED WARRANTIES OF MERCHANTABILITY AND FITNESS FOR A PARTICULAR PURPOSE. No liability is assumed for errors contained herein or for incidental or consequential damages in connection with the furnishing, performance, or use of this material. This document contains proprietary information which is protected by copyright. No part of this document may be photocopied, reproduced, or translated into another language without prior written consent.

**Copyright:** Copyright © 2003 Veeco Instruments Inc. All rights reserved.

**Trademark Acknowledgments:** The following are registered trademarks of Veeco Instruments Inc. All other trademarks are the property of their respective owners.

**Product Names:**

NanoScope®  
MultiMode™  
Dimension™  
BioScope™  
Atomic Force Profiler™ (AFP™)  
Dektak®

**Software Modes:**

TappingMode™  
Tapping™  
TappingMode+™  
LiftMode™  
AutoTune™  
TurboScan™  
Fast HSG™  
PhaseImaging™  
DekMap 2™  
HyperScan™  
StepFinder™  
SoftScan™

**Hardware Designs:**

TrakScan™  
StiffStage™

**Hardware Options:**

TipX®  
Signal Access Module™ and SAM™  
Extender™  
TipView™  
Interleave™  
LookAhead™  
Quadrex™

**Software Options:**

NanoScript™  
Navigator™  
FeatureFind™

**Miscellaneous:**

NanoProbe®

---

# Table of Contents

---

1.0 History and Definitions in SPMs .....	3
1.1 History .....	3
1.2 Definitions .....	3
1.3 Other forms of SPM: .....	4
2.0 Scanning Tunneling Microscope .....	5
2.1 Applications .....	7
3.0 Contact Mode AFM .....	8
4.0 TappingMode AFM .....	10
5.0 Non-contact Mode AFM .....	11
6.0 Advantages and Disadvantages of Contact Mode AFM, TappingMode AFM, and Non-contact Mode AFM .....	12
6.1 Contact Mode AFM .....	12
6.2 TappingMode AFM .....	12
6.3 Non-contact Mode AFM .....	13
7.0 Piezoelectric Scanners: How They Work.....	14
8.0 Piezoelectric Scanners: Hysteresis and Aging .....	16
8.1 Hysteresis .....	16
8.2 Aging .....	18
9.0 Piezoelectric Scanners: Creep and Bow.....	19
9.1 Creep .....	19
9.2 Bow .....	20
10.0 Probes.....	21
10.1 Silicon Nitride .....	21
10.2 Silicon.....	22
11.0 Types of SPM Probes .....	23
11.1 Contact Mode Probes .....	23
11.2 TappingMode Probes .....	23
11.3 Probes for Other SPM Techniques .....	23
12.0 Atomic Force Microscopy- Beam Deflection Detection .....	25

---



---

13.0 SPM Configurations .....	26
14.0 Abbreviated Instructions for Dimension Series AFMs.....	29
14.1 Mode of Operation .....	29
14.2 Align the Laser .....	29
14.3 Adjust the Photodetector.....	29
14.4 Locate Tip.....	29
14.5 Focus Surface .....	30
14.6 Cantilever Tune (TappingMode Only) .....	30
14.7 Set Initial Scan Parameters.....	30
14.8 Engage .....	30
14.9 Adjust Scan Parameters .....	31
14.10 Set Desired Scan Size, Scan Angle, and Offsets .....	31
15.0 Abbreviated Instructions for the MultiMode AFM.....	32
15.1 Mode of Operation .....	32
15.2 Mount Probe .....	32
15.3 Select Scanner .....	32
15.4 Mount Sample .....	32
15.5 Place Optical Head on Scanner .....	32
15.6 Align Laser and Tip-Sample Approach (2 Methods) .....	33
15.7 Adjust Photodiode Signal.....	34
15.8 Cantilever Tune (TappingMode Only) .....	34
15.9 Set Initial Scan Parameters.....	34
15.10 Engage .....	34
15.11 Adjust Scan Parameters .....	35
15.12 Set Desired Scan Size, Scan Angle, and Offsets .....	35
16.0 Realtime Operation .....	36
16.1 Setpoint.....	36
16.2 Integral Gain.....	37
16.3 Scan Rate .....	38
16.4 Other Important Parameters .....	39
17.0 Force Curves .....	42
18.0 Offline Operation .....	44
18.1 File Handling .....	44
18.2 Image Analysis .....	44
18.3 Filters .....	47
19.0 Tip Shape Issues .....	53
19.1 Resolution Issues .....	56
20.0 Typical Image Artifacts.....	58
21.0 Calibration.....	62

# SPM Training Notebook

---

This Notebook is intended to be used as an introduction by the first-time user of Veeco Instruments NanoScope Scanning Probe Microscopes (SPM). For further information, please consult the Command Reference Manual and/or the appropriate NanoScope manual.

**Specifically, this manual covers the following:**

- **History and Definitions in SPMs:** [Page 3](#)
- **Scanning Tunneling Microscope:** [Page 5](#)
- **Contact Mode AFM:** [Page 8](#)
- **TappingMode AFM:** [Page 10](#)
- **Non-contact Mode AFM:** [Page 11](#)
- **Advantages and Disadvantages of Contact Mode AFM, TappingMode AFM, and Non-contact Mode AFM:** [Page 12](#)
- **Piezoelectric Scanners: How They Work:** [Page 14](#)
- **Piezoelectric Scanners: Hysteresis and Aging:** [Page 16](#)
- **Piezoelectric Scanners: Creep and Bow:** [Page 19](#)
- **Probes:** [Page 21](#)
- **Types of SPM Probes:** [Page 23](#)
- **Atomic Force Microscopy- “Beam Deflection” Detection:** [Page 25](#)
- **SPM Configurations:** [Page 26](#)
- **Abbreviated Instructions for Dimension Series AFMs:** [Page 29](#)
- **Abbreviated Instructions for the MultiMode AFM:** [Page 32](#)
- **Realtime Operation:** [Page 36](#)
- **Force Curves:** [Page 42](#)

- 
- **Offline Operation:** [Page 44](#)
  - **Tip Shape Issues:** [Page 53](#)
  - **Typical Image Artifacts:** [Page 58](#)
  - **Calibration:** [Page 62](#)

## 1.0 History and Definitions in SPMs

### 1.1 History

Scanning Tunneling Microscope (STM)

- Developed in 1982 by Binnig, Rohrer, Gerber, and Weibel at IBM in Zurich, Switzerland.
- Binnig and Rohrer won the Nobel Prize in Physics for this invention in 1986.

Atomic Force Microscope (AFM)

- Developed in 1986 by Binnig, Quate, and Gerber as a collaboration between IBM and Stanford University.

### 1.2 Definitions

**Scanning Probe Microscopy (SPM):** Consists of a family of microscopy forms where a sharp probe is scanned across a surface and probe/sample interaction is monitored.

The two primary forms of SPM:

1. Scanning Tunneling Microscopy (STM)
2. Atomic Force Microscopy (AFM) (also called Scanning Force Microscopy (SFM))
  - There are 3 primary modes of AFM:
    - Contact Mode AFM
    - Non-contact Mode AFM
    - Tapping Mode AFM

### 1.3 Other forms of SPM:

Lateral Force Microscopy (LFM)

Force Modulation Microscopy

Magnetic Force Microscopy (MFM)

Electric Force Microscopy (EFM)

Surface Potential Microscopy

Phase Imaging

Force Volume

Electrochemical STM & AFM (ECM)

Scanning Capacitance Microscopy (SCM)

Scanning Thermal Microscopy (SThM)

Near-field Scanning Optical Microscopy (NSOM or SNOM)

Scanning Spreading Resistance (SSRM)

Tunneling AFM (TUNA)

Conductive AFM (CAFM)

NanoIndentation

Torsional Resonance Mode (TR Mode)

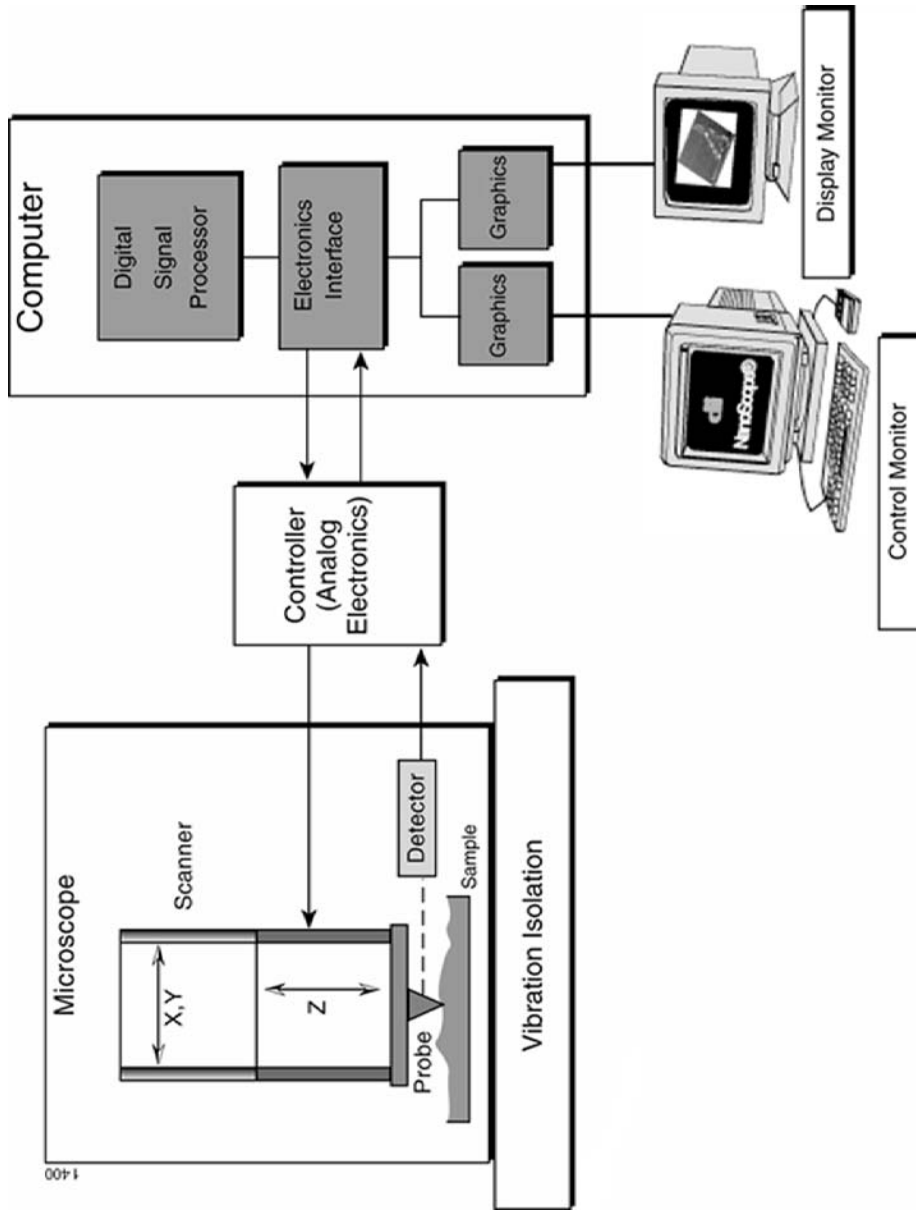
NanoLithography / NanoManipulation

SECPM

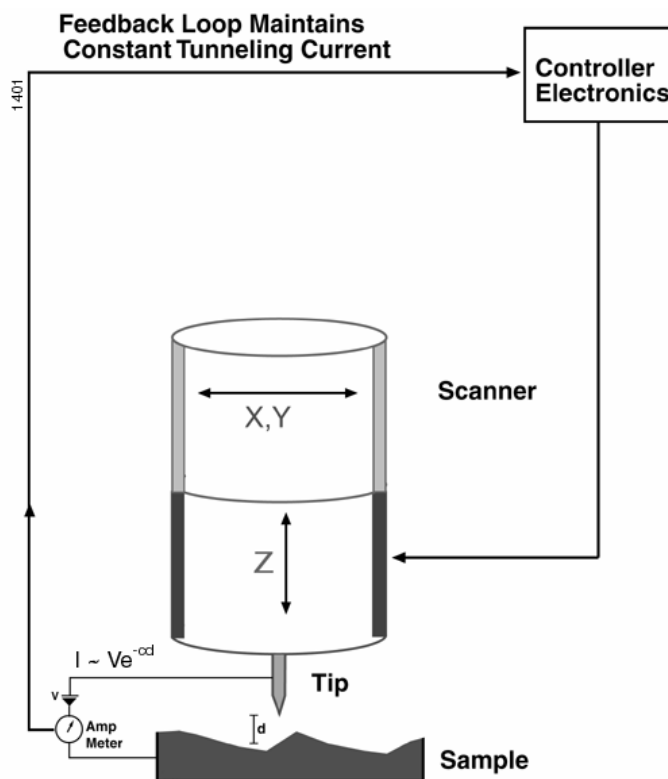


## 2.0 Scanning Tunneling Microscope

### Basic SPM Components



**Figure 2.0a** Feedback Loop Maintains Constant Tunneling Current



STM is based on the fact that the tunneling current between a conductive tip and sample is exponentially dependent on their separation.

This can be represented by the equation:  $I \sim Ve^{-cd}$

- $I$  = Tunneling current
- $V$  = Bias voltage between tip and sample
- $c$  = constant
- $d$  = tip-sample separation distance

As the tip scans the sample surface, it encounters sample features of different heights, resulting in an exponential change in the tunneling current.

A feedback loop is used to maintain a constant tunneling current during scanning by vertically moving the scanner at each  $(x,y)$  data point until a “setpoint” current is reached.

The vertical position of the scanner at each  $(x,y)$  data point is stored by the computer to form the topographic image of the sample surface.

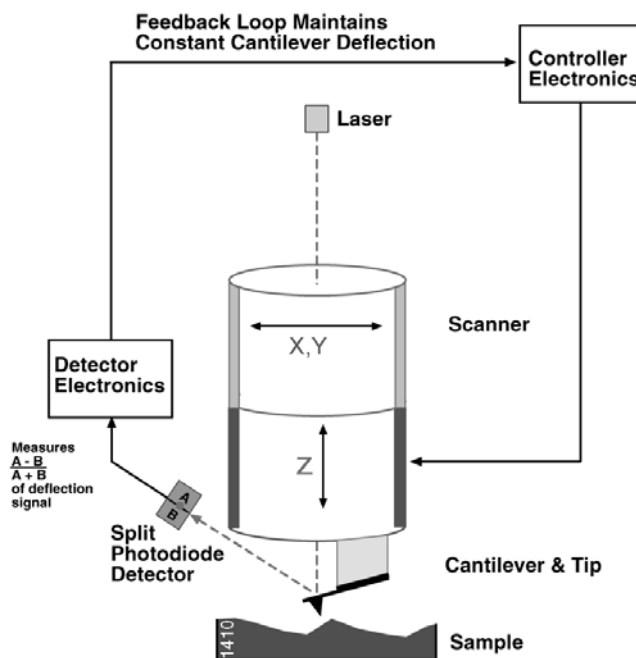
This technique is typically limited to conductive and semiconducting surfaces

## 2.1 Applications

- Atomic resolution imaging (STM is the only technique which detects atomic-scale defects)
- Electrochemical STM
- Scanning Tunneling Spectroscopy
- Low-current imaging of poorly conductive samples

### 3.0 Contact Mode AFM

Figure 3.0a Feedback Loop Maintains Constant Cantilever Deflection



Contact mode AFM operates by scanning a tip attached to the end of a cantilever across the sample surface while monitoring the change in cantilever deflection with a split photodiode detector. The tip contacts the surface through the adsorbed fluid layer on the sample surface.

A feedback loop maintains a constant deflection between the cantilever and the sample by vertically moving the scanner at each (x,y) data point to maintain a “setpoint” deflection. By maintaining a constant cantilever deflection, the force between the tip and the sample remains constant.

The force is calculated from Hooke's Law:  $F = -kx$  where:

- $F$  = Force
- $k$  = spring constant
- $x$  = cantilever deflection.

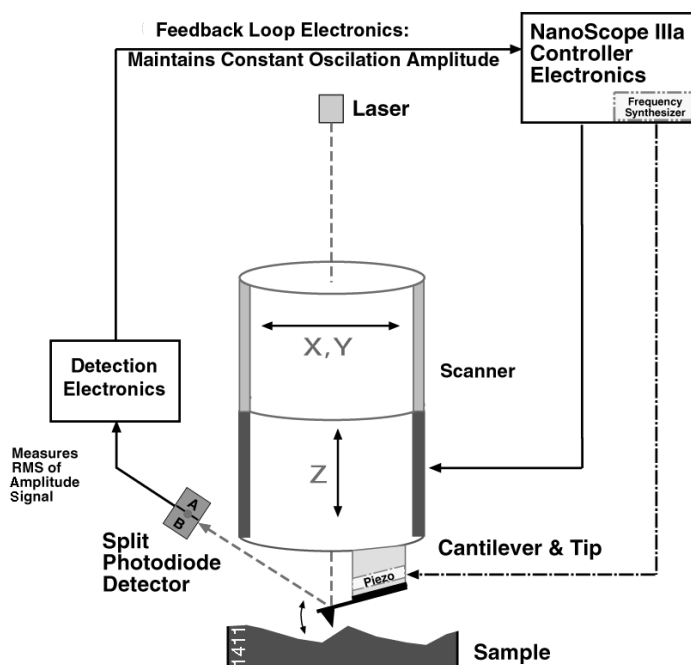
Force constants usually range from 0.01 to 1.0 N/m, resulting in forces ranging from nN to  $\mu$ N in an ambient atmosphere.

The distance the scanner moves vertically at each (x,y) data point is stored by the computer to form the topographic image of the sample surface.

Operation can take place in ambient and liquid environments.

## 4.0 TappingMode AFM

Figure 4.0a Feedback Loop Electronics



TappingMode AFM operates by scanning a tip attached to the end of an oscillating cantilever across the sample surface.

The cantilever is oscillated at or slightly below its resonance frequency with an amplitude ranging typically from 20nm to 100nm. The tip lightly “taps” on the sample surface during scanning, contacting the surface at the bottom of its swing.

The feedback loop maintains a constant oscillation amplitude by maintaining a constant RMS of the oscillation signal acquired by the split photodiode detector.

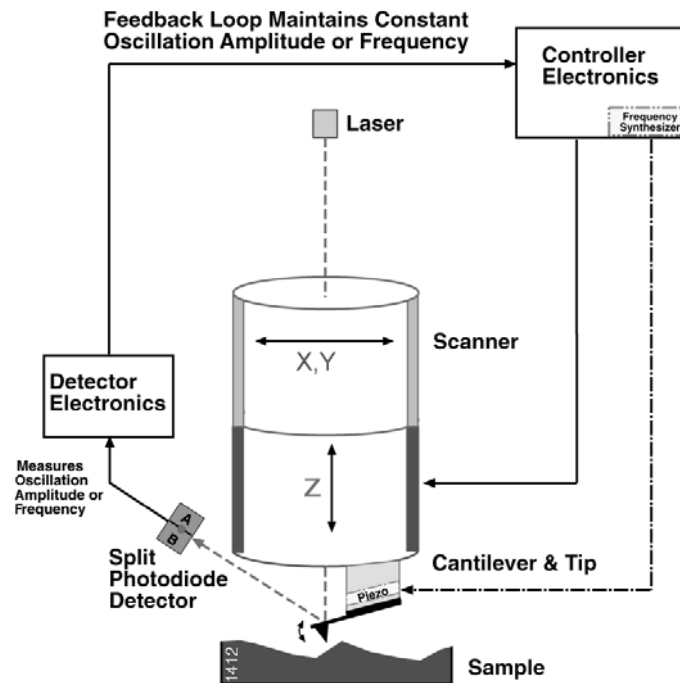
The vertical position of the scanner at each (x,y) data point in order to maintain a constant “setpoint” amplitude is stored by the computer to form the topographic image of the sample surface. By maintaining a constant oscillation amplitude, a constant tip-sample interaction is maintained during imaging.

Operation can take place in ambient and liquid environments. In liquid, the oscillation need not be at the cantilever resonance.

When imaging in air, the typical amplitude of the oscillation allows the tip to contact the surface through the adsorbed fluid layer without getting stuck.

## 5.0 Non-contact Mode AFM

**Figure 5.0a** Feedback Loop Maintains Constant Oscillation Amplitude or Frequency



The cantilever is oscillated at a frequency which is slightly above the cantilever's resonance frequency typically with an amplitude of a few nanometers (<10nm), in order to obtain an AC signal from the cantilever.

The tip does not contact the sample surface, but oscillates above the adsorbed fluid layer on the surface during scanning

The cantilever's resonant frequency is decreased by the van der Waals forces, which extend from 1nm to 10nm above the adsorbed fluid layer, and by other long range forces which extend above the surface. The decrease in resonant frequency causes the amplitude of oscillation to decrease.

The feedback loop maintains a constant oscillation amplitude or frequency by vertically moving the scanner at each (x,y) data point until a "setpoint" amplitude or frequency is reached.

The distance the scanner moves vertically at each (x,y) data point is stored by the computer to form the topographic image of the sample surface.

## 6.0 Advantages and Disadvantages of Contact Mode AFM, TappingMode AFM, and Non-contact Mode AFM

### 6.1 Contact Mode AFM

#### Advantages:

- High scan speeds (throughput).
- Contact mode AFM is the only AFM technique which can obtain “atomic resolution” images.
- Rough samples with extreme changes in vertical topography can sometimes be scanned more easily in contact mode.

#### Disadvantages:

- Lateral (shear) forces can distort features in the image.
- The forces normal to the tip-sample interaction can be high in air due to capillary forces from the adsorbed fluid layer on the sample surface.
- The combination of lateral forces and high normal forces can result in reduced spatial resolution and may damage soft samples (i.e., biological samples, polymers, silicon) due to scraping between the tip and sample.

### 6.2 TappingMode AFM

#### Advantages:

- Higher lateral resolution on most samples (1nm to 5nm).
- Lower forces and less damage to soft samples imaged in air.
- Lateral forces are virtually eliminated, so there is no scraping.

#### Disadvantages:

- Slightly slower scan speed than contact mode AFM.



### 6.3 Non-contact Mode AFM

Advantage:

- No force exerted on the sample surface.

Disadvantages:

- Lower lateral resolution, limited by the tip-sample separation.
- Slower scan speed than TappingMode and Contact Mode to avoid contacting the adsorbed fluid layer which results in the tip getting stuck.
- Non-contact usually only works on extremely hydrophobic samples, where the adsorbed fluid layer is at a minimum. If the fluid layer is too thick, the tip becomes trapped in the adsorbed fluid layer causing unstable feedback and scraping of the sample.

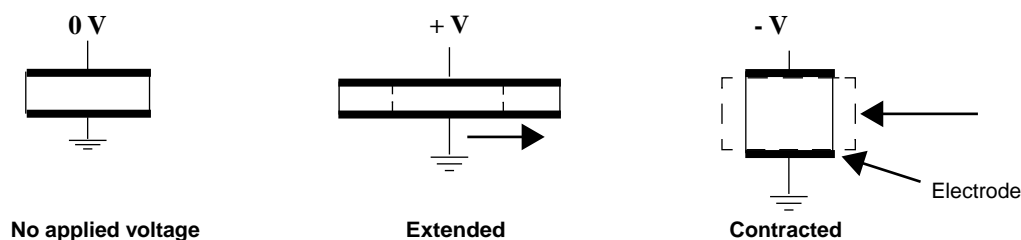
**Note:** Due to these disadvantages, applications for non-contact mode AFM imaging have been limited.

## 7.0 Piezoelectric Scanners: How They Work

SPM scanners are made from piezoelectric material, which expands and contracts proportionally to an applied voltage.

Whether they elongate or contract depends upon the polarity of the voltage applied. All DI scanners have AC voltage ranges of +220V to -220V for each scan axis.

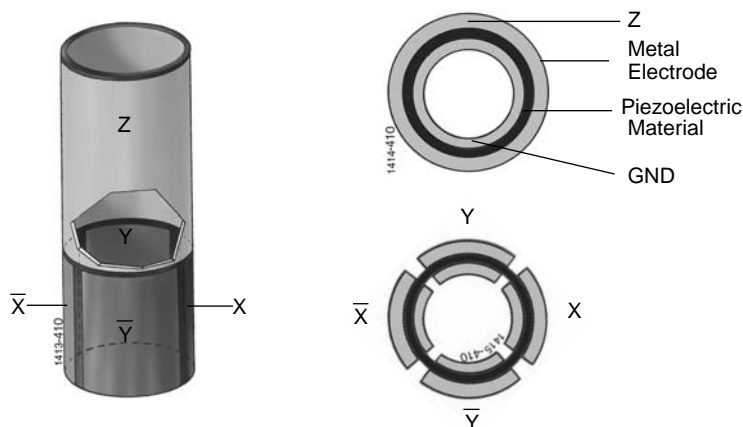
**Figure 7.0a** The effect of applied voltage on piezoelectric materials.



The scanner is constructed by combining independently operated piezo electrodes for X, Y, & Z into a single tube, forming a scanner which can manipulate samples and probes with extreme precision in 3 dimensions.

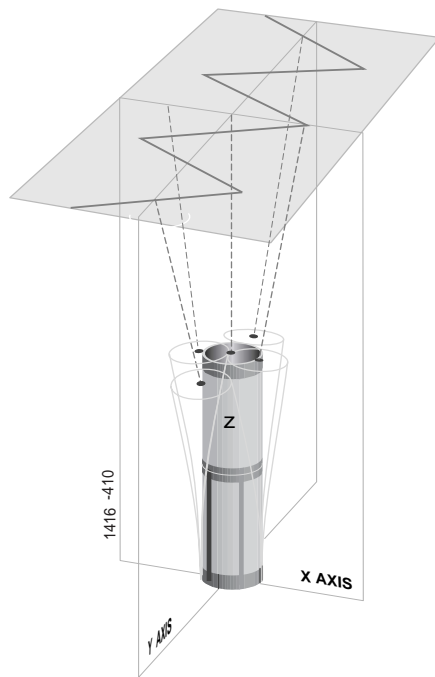
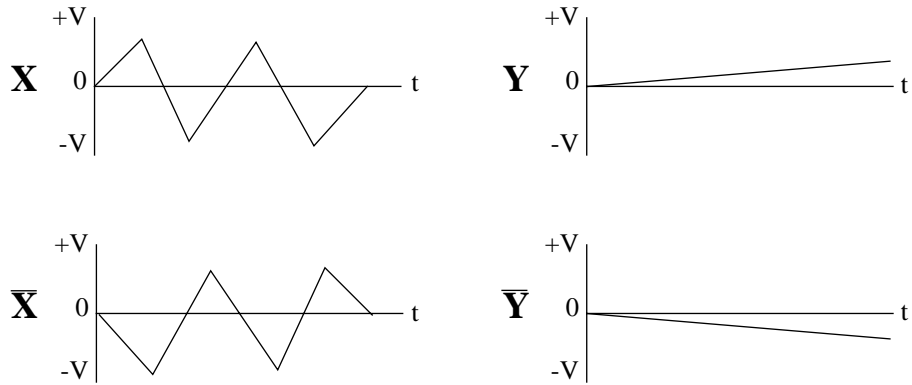
In some models (e.g. MultiMode SPM) the scanner tube moves the sample relative to the stationary tip. In other models (e.g., STM, Dimension Series and BioScope SPM's) the sample is stationary while the scanner moves the tip.

**Figure 7.0b** Typical scanner piezo tube and X-Y-Z configurations. AC Signals applied to conductive areas of the tube create piezo movement along the three major axes



AC voltages applied to the different electrodes of the piezoelectric scanner produce a scanning raster motion in X and Y. There are two segments of the piezoelectric crystal for X (X & X) and Y (Y & Y).

**Figure 7.0c** Waveforms applied to the piezo electrodes during a raster scan with the X axis designated as the fast axis (Scan Angle = 0°)



Schematic of piezo movement during a raster scan. Voltage applied to the X- and Y-axes produce the scan pattern.

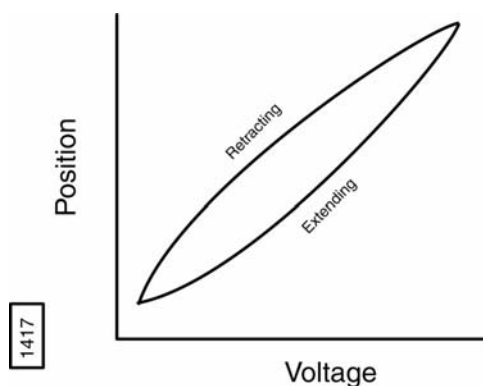
## 8.0 Piezoelectric Scanners: Hysteresis and Aging

### 8.1 Hysteresis

Because of differences in the material properties and dimensions of each piezoelectric element, each scanner responds differently to an applied voltage. This response is conveniently measured in terms of sensitivity, a ratio of piezo movement-to-piezo voltage, i.e., how far the piezo extends or contracts per applied volt.

Sensitivity is not a linear relationship with respect to scan size. Because piezo scanners exhibit more sensitivity (i.e., more movement per volt) at the end of a scan line than at the beginning, the relationship of movement vs. applied voltage is nonlinear. This causes the forward and reverse scan directions to behave differently and display hysteresis between the two scan directions.

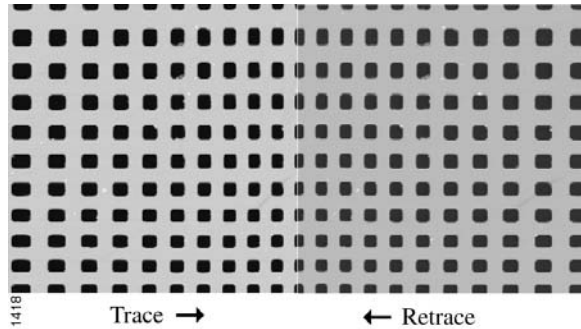
**Figure 8.1a** Effect of Nonlinearity and Hysteresis



The effect of nonlinearity and hysteresis can be seen from the curve above (see [Figure 8.1a](#)). As the piezo extends and retracts throughout its full range, it moves less per applied volt at the beginning of the extension than near the end. The same is true when the piezo is retracting - the piezo moves less per applied volt at the beginning of its extension than near the end.

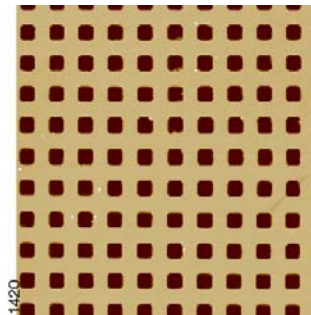
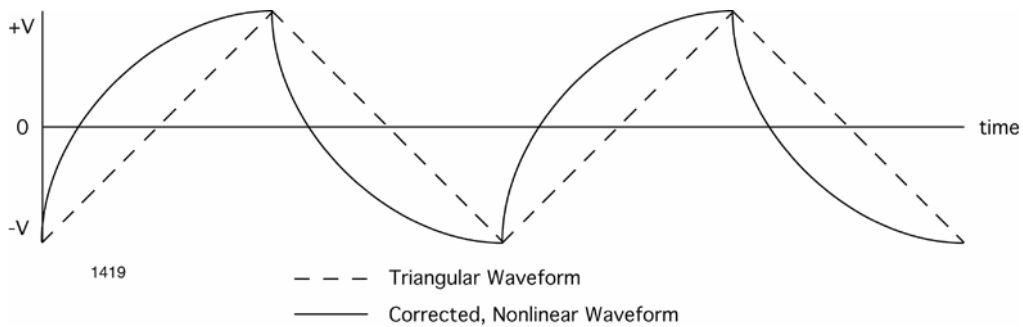
Nonlinearity and hysteresis can cause feature distortion in SPM images if not properly corrected. Examples of these effects on AFM images are shown below with the DI-supplied 10  $\mu\text{m}$  pitch calibration grating. The depth of each square is 200nm. Please refer to the standard for step height information.

**Figure 8.1b** 100mm x 100mm scans in the forward (trace) and reverse (retrace) directions of a two-dimensional 10mm pitch grating without linearity correction. Both scans are in the down direction. Notice the differences in the spacing, size, and shape of the pits between the bottom and the top of each image. The effect of the hysteresis loop on each scan direction is demonstrated.



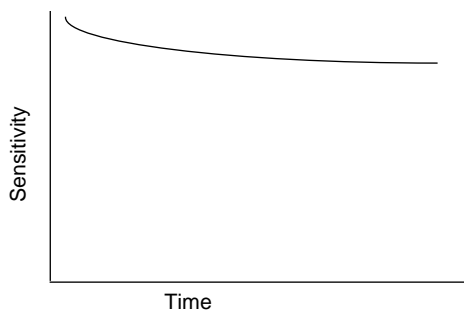
This nonlinear relationship is corrected during the calibration routine by applying a nonlinear voltage in Realtime to produce a linear scan in X and Y in both trace and retrace scan directions. (U.S. Pat. #5,051,646)

**Figure 8.1c** Nonlinear waveform (solid line) applied to the piezo electrodes to produce linear scanner movement. The unaltered triangular waveform (dashed line) is included for reference.



100µm x 100µm scan of the same two-dimensional 10µm pitch calibration grating with a nonlinear scan voltage. Notice the equal spacing between all pits and the consistent shape and size of pits throughout the image.

## 8.2 Aging



The sensitivity of piezoelectric materials decreases exponentially with operation time. This causes most of the change in the sensitivity to occur at the beginning of a scanner's life, as shown in the graph to the left. Scanners are run approximately 48 hours before they are shipped from the factory to get the scanner past the point where the sensitivity changes dramatically over short periods of time. As the scanner ages, the sensitivity will change less with time, and will eventually get to the point where it very seldom needs recalibrating.

## 9.0 Piezoelectric Scanners: Creep and Bow

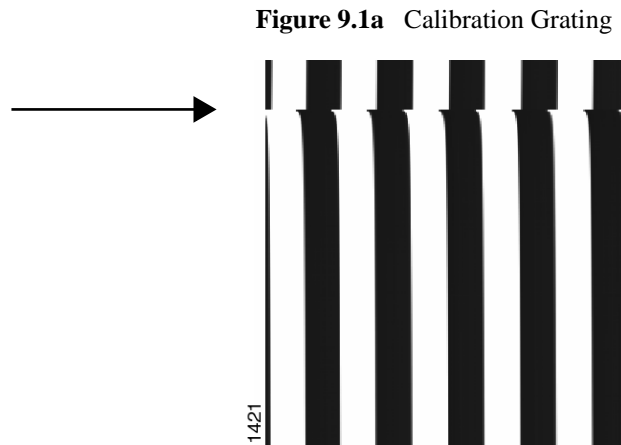
### 9.1 Creep

Creep is the drift of the piezo displacement after a DC offset voltage is applied to the piezo.

This may occur with large changes in X & Y offsets, and when using the frame up and frame down commands when the piezo travels over most of the scan area to restart the scan.

When a large offset is performed, the scanner stops scanning and a DC voltage is applied to the scanner to move the requested offset distance. However, the scanner does not move the full offset distance all at once. It initially moves the majority of the offset distance quickly, and then slowly moves over the remainder. The scanning resumes after a majority of the offset distance has been moved although the scanner is still slowly moving in the direction of the offset. Creep is the result of this slow movement of the piezo over the remainder of the offset distance once scanning has resumed.

Creep appears in the image as an elongation and stretching of features in the direction of the offset for a short period of time after the offset.



An example of creep is shown in the image of a calibration grating (see [Figure 9.1a](#)). The tip was scanning from top to bottom and an offset of  $10\mu\text{m}$  in the X direction was performed near the beginning of the scan (indicated by the arrow). The slight bending of the lines which occurs directly after performing the offset are due to creep. The creep settles out by the end of the scan.

When creep appears in the image, it will often settle out by the end of the scan and the next image may be captured. For very large offsets ( $>50\mu\text{m}$ ), it may take longer than 1 scan for the creep to settle out. The creep can be reduced by offsetting beyond the desired point and then offsetting back to the desired point.

## 9.2 Bow

Because scanners are attached at one end and move the sample or tip on the other, the free end does not move in a level plane. The mechanical properties of the piezo, as well as the kinematics of motion, often result in 2nd order or 3rd order curvatures from an ideal plane. This is commonly called “Bow”, which increases with scan size. The bows can be removed from a captured image by using **Modify Planefit Manual** or **Auto**.



## 10.0 Probes

### 10.1 Silicon Nitride

Silicon nitride probes consist of a cantilever integrated with a sharp tip on the end. The properties and dimensions of the cantilever play an important role in determining the sensitivity and resolution of the AFM.

For contact mode AFM imaging, it is necessary to have a cantilever which is soft enough to be deflected by very small forces (i.e. small force constant) and has a high enough resonant frequency to not be susceptible to vibrational instabilities. This is accomplished by making the cantilever short, to provide a high resonant frequency, and thin, to provide a small force constant.

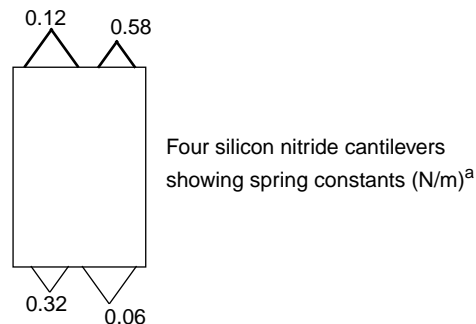
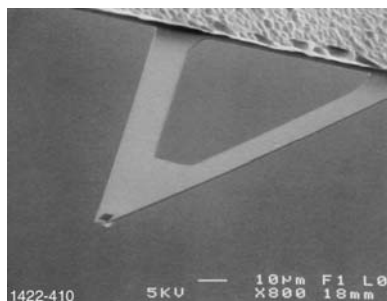
For the silicon nitride tips, there are 4 cantilevers with different geometries attached to each substrate, resulting in 4 different spring constants.

Characteristics of the standard silicon nitride probes (Models NP & DNP) are listed below:

**Table 10.1a** Silicon Nitride Probe Characteristics

Spring Constant (k)	0.58, 0.32, 0.12, 0.06 N/m <sup>a</sup>
Nominal Tip Radius of Curvature	20 - 60nm
Cantilever Lengths	100 & 200 $\mu$ m
Cantilever Configuration	V-shaped
Reflective Coating	Gold
Sidewall angles	35° on all 4 sides

- a. Calculated spring constant values are based on the 0.6 $\mu$ m silicon nitride thickness; however, this value can actually vary from 0.4 $\mu$ m to 0.7 $\mu$ m. Thickness is cubed in the spring constant calculation, thus, actual values can vary substantially.



## 10.2 Silicon

Silicon probes are used primarily for TappingMode applications. The tip and cantilever are an integrated assembly of single crystal silicon, produced by etching techniques.

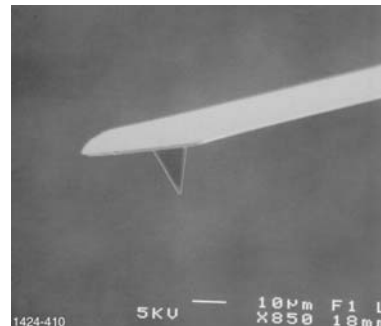
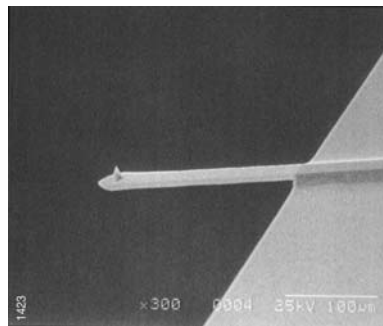
Only 1 cantilever and tip are integrated with each substrate. These probes can be much stiffer than the silicon nitride probes, resulting in larger force constants and resonant frequencies.

Characteristics of the TappingMode Etched Silicon Probes (Model TESP) are listed below:

**Table 10.2a** TappingMode Etched Silicon Probe (TESP) Characteristics

Spring Constant (k)	20 - 100 N/m
Resonant Frequency	200 - 400 kHz
Nominal Tip Radius of Curvature	5 - 10nm
Cantilever Length	125 $\mu$ m
Cantilever Configuration	Single Beam
Reflective Coating	Uncoated, Optional Al Coating

**Figure 10.2a** Scanned Electron Microscope (SEM) Images of Silicon Cantilever and Tip



## 11.0 Types of SPM Probes

### 11.1 Contact Mode Probes

- Standard Silicon Nitride Probe (described previously)
- Oxide-Sharpended Silicon Nitride (Standard) Probes
- Oxide-Sharpended Silicon Nitride Oriented Twin Tip Probes
- Olympus Oxide-Sharpended Silicon Nitride Probes
- Contact Etched Silicon Probes

### 11.2 TappingMode Probes

- TappingMode Etched Silicon Probes (described previously)
- Hardened TappingMode Etched Silicon Probes
- TappingMode Focused Ion Beam (FIB) Machined Silicon Probes
- Olympus Tapping Tips

### 11.3 Probes for Other SPM Techniques

#### Force Modulation Probes

- Force Modulation Etched Silicon Probes

#### Magnetic Force Microscopy (MFM) and Electric Force Microscopy (EFM) Probes

- Magnetic Force Etched Silicon (standard) Probes
- Low Moment Magnetic Force Etched Silicon Probes
- Low Coercivity Magnetic Force Etched Silicon Probes

#### Scanning Thermal Microscopy

- AFM Probes with Integrated Thermal Sensor for Scanning Thermal Microscopy

---

## Types of SPM Probes

---

### Nanoindentation

- Diamond-tipped Cantilever for Nanoindentation/Scratching

### Scanning Tunneling Microscopy (STM)

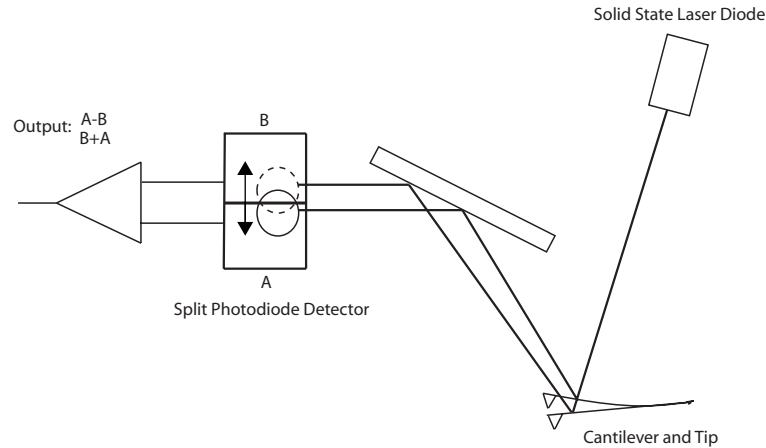
- Platinum-Iridium STM Tips
- Tungsten STM Tips

### Probes for Electrical Techniques

- PIT - PtIr-coated Si probes for SCM and TappingMode
- PIC - PtIr-coated Si probes for contact mode SCM
- DDESP - Doped diamond-coated Si probes, with medium to high spring constant

For a listing and description of SPM probes available from Veeco Instruments please go to:  
[www.veeco.com](http://www.veeco.com) > **Products** > **AFM/SPMs/NSOMS** > **Buy SPM Probes** > **Probes**.

## 12.0 Atomic Force Microscopy- “Beam Deflection” Detection



Used for Contact Mode AFM, Non-contact Mode AFM, and TappingMode AFM. This is the most widely used form of cantilever deflection detection

Laser light from a solid state diode is reflected off the back of the cantilever and collected by a position sensitive detector (PSD) consisting of two closely spaced photodiodes whose output signal is collected by a differential amplifier.

Angular displacement of cantilever results in one photodiode collecting more light than the other photodiode, producing an output signal (the difference between the photodiode signals normalized by their sum) which is proportional to the deflection of the cantilever.

It detects cantilever deflections  $< 1 \text{ \AA}$  (thermal noise limited). A long beam path (several cm) amplifies changes in beam angle.

### 13.0 SPM Configurations

Figure 13.0a Scanned Tip SPM

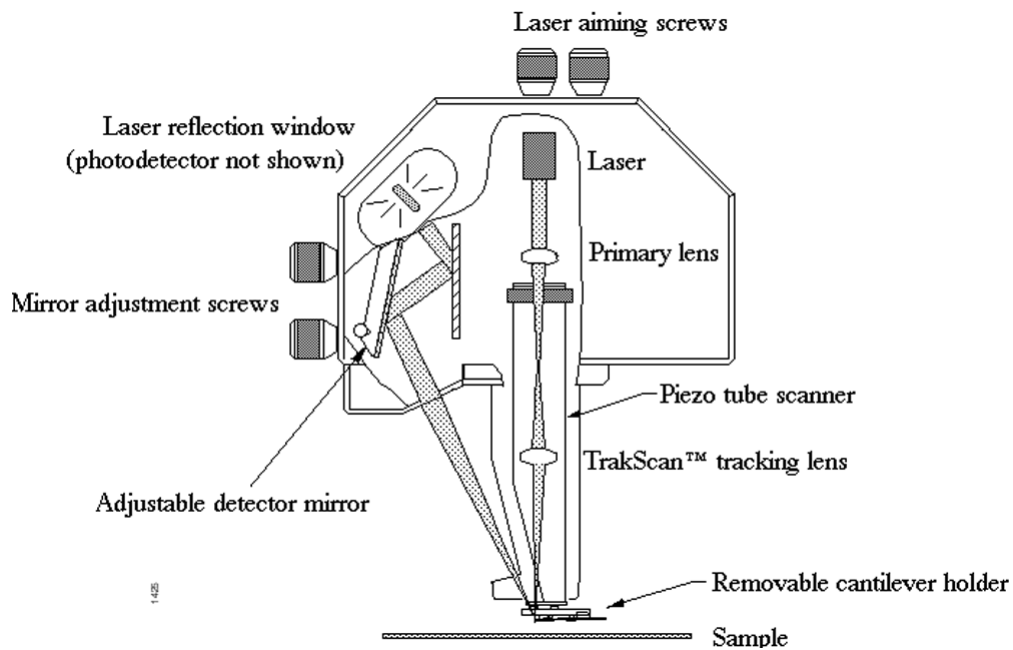
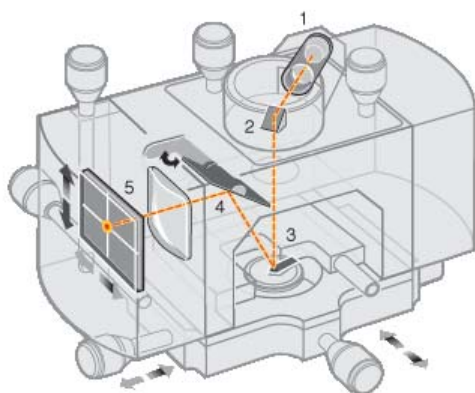
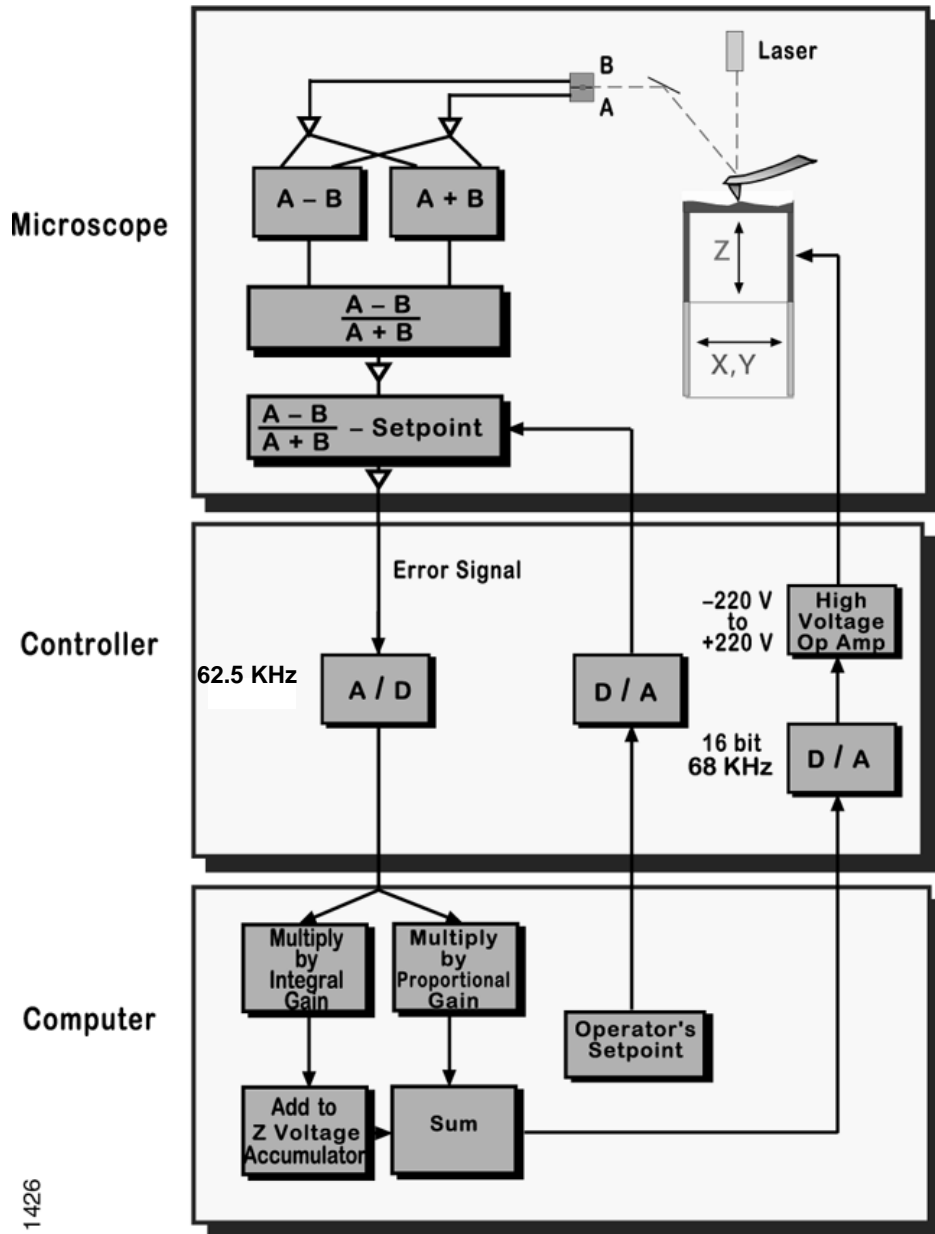


Figure 13.0b Scanned Sample SPM



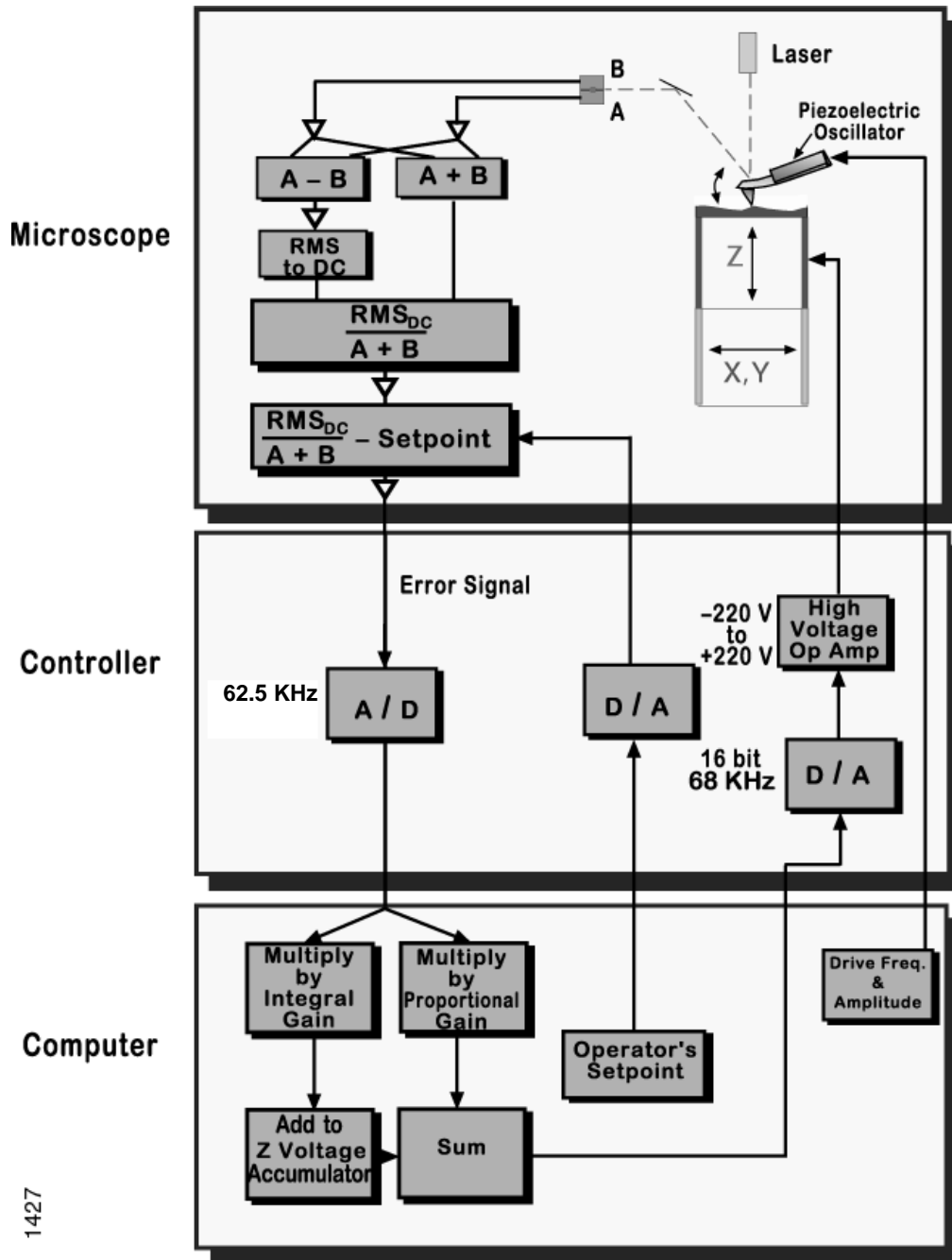
- Labels:**
- 1. Laser
  - 2. Mirror
  - 3. Cantilever
  - 4. Tilt mirror
  - 5. Photodetector

Figure 13.0c Feedback Loop- Contact Mode



1426

Figure 13.0d Feedback Loop- Tapping Mode



1427



## 14.0 Abbreviated Instructions for Dimension Series AFMs

### 14.1 Mode of Operation

1. In the **Other Controls** panel, set the **AFM Mode** to Tapping or Contact, or select **Microscope > Profile** and then the appropriate mode.
2. Mount the probe into the cantilever holder. Be sure that it is in firm contact with the end of the groove.
  - Tapping: Use an etched single crystal silicon probe (TESP).
  - Contact: Use a silicon nitride probe (DNP).
3. Mount the cantilever holder onto the end of the scanner head.

### 14.2 Align the Laser

Adjust the laser so that it is on the cantilever using the two screws on the top of the scanner.

- Tapping: The Sum signal should be about 2V.
- Contact: The Sum signal should be 4-6V.

### 14.3 Adjust the Photodetector

Adjust the photodetector so that the red dot moves towards the center of the square, using the two screws on the side of the scanner.

- Tapping: Center the red dot and set the vertical deflection (**Vert Defl**) to a value close to 0.0 volts.
- Contact: **Horiz Defl** should be about 0.0 volts, and **Vert Defl** should be about -2.0 volts.

### 14.4 Locate Tip

1. Using the mouse, select **Stage > Locate Tip** (or click on the **Locate Tip** icon).
2. Center the tip on the cantilever under the cross hairs using the two adjustment screws to the left of the optical objective on the microscope.
3. Focus on the tip end of the cantilever using the trackball while holding down on the bottom left button.



## 14.5 Focus Surface



1. Select **Stage > Focus Surface** (or click the **Focus Surface** icon). The optics will move to a focus position approximately 1mm below the tip. Focus on the sample surface by rolling the trackball up or down while pressing the bottom left button. This adjustment raises or lowers the vertical engage stage on which the SPM and optics are mounted. Care must be taken when making this adjustment to ensure that the tip does not hit the sample surface.
2. Move the desired measurement point under the cross hairs with the trackball without holding down any of the buttons

## 14.6 Cantilever Tune (TappingMode Only)



1. Select **View > Sweep > Cantilever Tune** (or click the **Cantilever Tune** icon). For Auto Tune Controls, make sure the Start Frequency is at 100 kHz and the End Frequency is at 500 kHz. Target Amplitude should be 2-3V.
2. Click **Auto Tune**. A “**Tuning...**” sign should appear and then disappear once Auto Tune is done. When done, quit the **Cantilever Tune** menu.
3. Set the **Peak Offset** to 3-10 percent. The **Peak Offset** is the percentage of the cantilever’s free-air resonant frequency to be automatically offset. Peak offset is used to compensate for changes in resonance before engagement due to the tip’s interaction with the surface after engagement. *Range and Settings:* 0-50 percent. Positive values offset the **Drive frequency** rightward on the graph.

## 14.7 Set Initial Scan Parameters

In the **Scan Controls** panel, set the initial **Scan Size** to 1 $\mu$ m, **X and Y Offsets** to 0, and **Scan Angle** to 0.

- Tapping: In the **Feedback Controls** panel, set **Integral Gain** to 0.4, **Proportional Gain** to 0.6, and **Scan Rate** to 2 Hz.
- Contact: In the **Feedback Controls** panel, set the **Setpoint** is to 0V, **Integral Gain** to 2.0, **Proportional Gain** to 3.0, and **Scan Rate** to 2 Hz.



## 14.8 Engage



Select **Motor > Engage** (or on the **Engage** icon).

## 14.9 Adjust Scan Parameters

### Tapping

1. Select **View > Scope Mode** (or click on the **Scope Mode** icon). 
2. Check to see if **Trace** and **Retrace** are tracking each other well (i.e. look similar). If they are tracking, the lines should look the same, but they will not necessarily overlap each other, either horizontally or vertically.
3. If they are tracking well, then your tip is scanning on the sample surface. You may want to try keeping a minimum force between the tip and sample by clicking on **Setpoint** and using the right arrow key to increase the Setpoint value gradually, until the tip lifts off the surface (at this point the Trace and Retrace will no longer track each other). Then decrease the Setpoint with the left arrow key until the Trace and Retrace follow each other again. Decrease the **Setpoint** one or two arrow clicks more to make sure that the tip will continue to track the surface. Choose **View > Image Mode** (or click on the **Image Mode** icon) to view the image.
4. If they are not tracking well, adjust the **Scan Rate**, **Gains** and/or **Setpoint** to improve the tracking. If Trace and Retrace look completely different, you may need to decrease the setpoint one or two clicks with the left arrow key until they start having common features in both scan directions. Then, reduce **Scan Rate** to the lowest speed with which you feel comfortable. For scan sizes of 1-3 $\mu$ m try scanning at 2Hz; for 5-10 $\mu$ m, try 1Hz; and for large scans, try 1.0-0.5Hz. Next, try increasing the **Integral Gain** using the right arrow key. As you increase the **Integral Gain**, increase the **Proportional Gain** as well (Proportional Gain can usually be 30-100% more than Integral Gain). The tracking should improve as the gains increase, although you will reach a value beyond which the noise will increase as the feedback loop starts to oscillate. If this happens reduce the gains until the noise goes away. If Trace and Retrace still do not track satisfactorily, the last thing to try is to reduce the **Setpoint**. Once the tip is tracking the surface, choose **View > Image Mode** (or select the **Image Mode** icon) to view the image. 

### Contact

- Once engaged, increase the **Setpoint** by using the right arrow key and observe the **Z-Center Position**. If the line in the Z-Center Position moves far to the extended end, the tip has false engaged. Increase the setpoint by +2 volts and execute the engage command again. If the Z-Center Position does not change greatly, you are probably on the sample surface and should go to **View > Scope Mode** to see how well Trace and Retrace are tracking each other. Adjust the **Gains**, **Scan Rate**, and **Setpoint** if needed. Remember that in Contact mode, increasing the Setpoint increases the force on the sample. Minimizing the imaging force is recommended for most applications.

## 14.10 Set Desired Scan Size, Scan Angle, and Offsets

Once the scan parameters are optimized, scan size and other features may be adjusted for capturing images for analysis. When changing the scan size value, keep in mind that the scan rate will need to be lowered for larger scan sizes.

## 15.0 Abbreviated Instructions for the MultiMode AFM

### 15.1 Mode of Operation

In the **Other Controls** panel, set **AFM Mode** to Tapping, Contact, or choose the appropriate profile and change the mode switch on the base to **TMAFM** or **AFM & LFM** mode, respectively.

### 15.2 Mount Probe

1. Mount a probe into the cantilever holder. Be sure that it is in firm contact with the end of the groove.
  - Tapping: Use an etched single crystal silicon probe (TESP).
  - Contact: Use a silicon nitride probe (NP).
2. Put the cantilever holder in the optical head. Secure the holder by tightening the screw in the back of the optical head.

### 15.3 Select Scanner

Choose a scanner (A, E, or J). Mount and plug the scanner into the base. Attach the corresponding springs to the microscope base. In the software, choose the appropriate scanner parameters with **Microscope > Select**.

### 15.4 Mount Sample

Mount a sample on a metal disk with a “sticky-tab” (sample width should be limited to the disk’s 15mm diameter). Mount the disk and sample on top of the scanner.

### 15.5 Place Optical Head on Scanner

1. Raise all three coarse-adjust screws on the scanner so that there is enough clearance between the tip and sample when the optical head is placed on the scanner. If using a JV or EV scanner, you only need to raise the motor screws.
2. Place the optical head on the scanner, still checking that the tip doesn’t touch the sample. Attach the springs to the optical head.
3. Plug in the connector from the optical head to the base.
4. Bring the tip close to the sample keeping the head level by lowering all three coarse-adjust screws.

## 15.6 Align Laser and Tip-Sample Approach (2 Methods)

1. Magnifier Method for Aligning Laser and Tip-Sample:
  - a. Focus on the side-view of the cantilever with the magnifier. If you are having trouble finding the cantilever, try searching for the red light of the laser and focus on that. Use the “paper method” described below for positioning the laser spot on the cantilever:
  - b. Move laser until it is at the front edge of the cantilever substrate. Move laser just off the front edge and move laterally along the edge looking for the reflection of the laser spot from the cantilever onto the paper. Center the laser on the cantilever at its end.
  - c. Keeping the optical head level, focus on the laser reflection of the cantilever and sample to bring the cantilever close to the sample. Use screws at the base of the optical head (front and left) to position the cantilever over the area of interest on the sample.
2. Optical Viewing Microscope Method for Aligning Laser and Tip-Sample
  - a. Place the microscope on the optical microscope positioning stage.
  - b. Turn on the monitor and the light source.
  - c. Focus on the cantilever (zoom out, if using optical microscope equipped with zoom). Use the base screws on the stage of the optical microscope to center the cantilever in the field of view. Lower the focus of the optical microscope to the sample surface. You will still see an out of focus “shadow” of the cantilever in the field of view. Keep the optical head level while lowering the cantilever until it is almost in the same plane of focus - keep the shadow of the cantilever in the field of view at all times. It is helpful to go up and check the focus on the cantilever from time to time to see how close it is to the sample surface.
  - d. Once the cantilever is close to the sample surface, adjust the laser so that it is positioned over the cantilever. Use the two screws at the top of the optical head to move the red laser spot onto the cantilever. You may need to change the field of view of the optical microscope initially to find the laser spot.
  - e. Next use the “paper method” (as described under Magnifier Method) to fine position the laser spot on the cantilever. Use the two screws at the base of the optical head (front and left) to position the cantilever over the area of interest on the sample. As the stepper motor moves during engagement, the cantilever will shift towards the back of the microscope (unless you are using a Vertical Engage Scanner). This means that you should place the cantilever in front of (below on the monitor) the area where you want to engage.

## 15.7 Adjust Photodiode Signal

Note where the laser reflection enters the photodiode cavity. If necessary, adjust the mirror (lever on back of optical head) to center the laser reflection into the photodiode cavity. Leave the mirror at an angle such that the **SUM** signal (circular meter in bottom LCD) is maximized.

- Tapping: Adjust the **Vertical Difference** value (bottom LCD) to zero using the screw on the top left side of the optical head.
- Contact: Set the **Contact AFM Output Signal** value (Vertical Difference, top LCD) to -2.0V using the screw on the top left side of the optical head. Adjust **Horizontal Difference** value (bottom LCD) to zero using the screw on the back, left side of the optical head.

## 15.8 Cantilever Tune (TappingMode Only)



Select **View > Cantilever Tune** (or select the **Cantilever Tune** icon). For Auto Tune Controls, make sure **Start Frequency** is at 100 kHz and **End Frequency** is at 500 kHz. **Target Amplitude** should be 2-3 volts. Click on **Auto Tune**. A “**Tuning...**” sign should appear and then disappear once Auto Tune is done. When finished, quit the Cantilever Tune menu.

## 15.9 Set Initial Scan Parameters

In **Scan Controls** panel, set the initial **Scan Size** to 1  $\mu\text{m}$ , **X** and **Y Offsets** to 0, and **Scan Angle** to 0.

- Tapping: In the **Feedback Controls** panel, set **Integral Gain** to 0.4, **Proportional Gain** to 0.6, and Scan Rate to 2 Hz.
- Contact: In the **Feedback Controls** panel, set the **Setpoint** is to 0 volts, the **Integral Gain** to 2.0, the **Proportional Gain** to 3.0, and the **Scan Rate** to 2 Hz.




## 15.10 Engage



Select **Motor > Engage** (or select the **Engage** icon).

## 15.11 Adjust Scan Parameters

### Tapping

- a. Select **View > Scope Mode** (or click on the **Scope Mode** icon). Check to see if the Trace and Retrace lines are tracking each other well (i.e. look similar). If they are tracking, the lines should look the same, but they will not necessarily overlap each other, either horizontally or vertically. 
- b. If they are tracking well, then your tip is scanning on the sample surface. You may want to try keeping a minimum force between the tip and sample by clicking on **Setpoint** and **Realtime** using the right arrow key to increase the Setpoint value gradually, until the tip lifts off the surface and the Trace and Retrace lines no longer track each other. Then decrease the Setpoint with the left arrow key until the Trace and Retrace follow each other again. To make sure that the tip will continue to track the surface, it is best to decrease the Setpoint one or two arrow clicks more with the left arrow key. Then select **View > Image Mode** (or click on the **Image Mode** icon) to view the image. 
- c. If they are not tracking well, adjust the **Scan Rate**, **Gains** and/or **Setpoint** to improve the tracking. If Trace and Retrace look completely different, you may need to decrease the Setpoint one or two clicks with the left arrow key until they start having common features in both scan directions. Then, reduce **Scan Rate** to the lowest speed with which you feel comfortable. For scan sizes of 1-3 $\mu\text{m}$  try scanning at 2Hz; for 5-10 $\mu\text{m}$ , try 1Hz; and for large scans, try 1.0-0.5Hz. Next, try increasing the **Integral Gain** using the right arrow key. As you increase the Integral Gain, increase the **Proportional Gain** as well (Proportional Gain can usually be 30-100% more than Integral Gain). The tracking should improve as the gains increase, although you will reach a value beyond which the noise will increase as the feedback loop starts to oscillate. If this happens, reduce the gains until the noise goes away. If Trace and Retrace still do not track satisfactorily, the last thing to try is to reduce the **Setpoint**. Once the tip is tracking the surface, select **View > Image Mode** (or click on the **Image Mode** icon) to view the image. 

### Contact

- Once engaged, increase the **Setpoint** by using the right arrow key and observe the **Z-Center Position**. If the line in the Z-Center Position moves far to the extended end, the tip has false engaged. Increase the setpoint by + 2 volts and execute the engage command again. If the Z-Center Position does not change greatly, you are probably on the sample surface and should go to **View > Scope Mode** to see how well Trace and Retrace are tracking each other. Adjust **Gains**, **Scan Rate**, and **Setpoint** if needed. Remember that in Contact mode, increasing the Setpoint increases the force on the sample. Minimizing the imaging force is recommended for most applications.

## 15.12 Set Desired Scan Size, Scan Angle, and Offsets

Once the scan parameters are optimized, scan size and other features may be adjusted for capturing images for analysis. When changing the scan size value, keep in mind that the scan rate will need to be lowered for larger scan sizes.

## 16.0 Realtime Operation

The Realtime parameters are located in the control panels which are available in the Panels pull down menu. The main control panels for topographic imaging are “Scan controls,” “Feedback Controls,” “Other Controls,” and “Channel 1.”

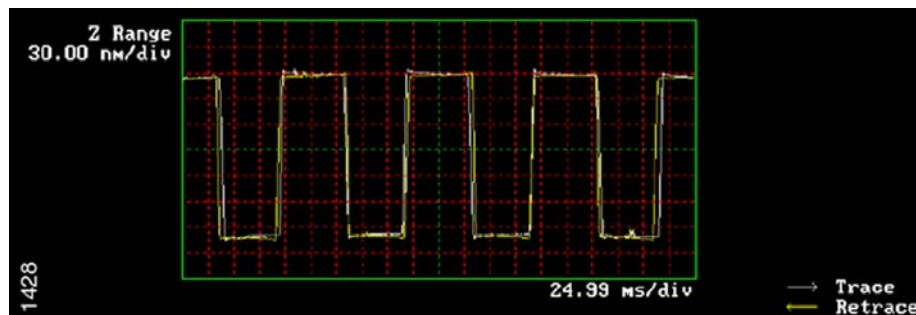
There are three primary feedback parameters that need adjusting every time you engage the microscope to capture an image in TappingMode AFM or Contact Mode AFM: **Setpoint**, **Integral Gain**, and **Scan Rate**.

To demonstrate how these parameters affect the image, examples of TappingMode operation on the 10 $\mu\text{m}$  x 10 $\mu\text{m}$  pitch calibration grating will be shown. These examples were acquired by viewing the **Scope Mode** (in the **View** menu), which displays a two-dimensional view (X vs. Z) of the Trace (left-to-right) and Retrace (right-to-left) scan lines being acquired in Realtime.

**Scope Mode** may be used to diagnose how well the tip is tracking the surface. If the feedback parameters are adjusted optimally, the trace and retrace scan lines should look very similar, but may not look completely identical.

An optimized scope trace of a 40 $\mu\text{m}$  TappingMode scan across the pits of the grating is shown below.

**Figure 16.0a** Scope Trace with Optimized Realtime Parameters



### 16.1 Setpoint

The Setpoint parameter tells the feedback loop what amplitude (TappingMode) or deflection (Contact Mode) to maintain during scanning.

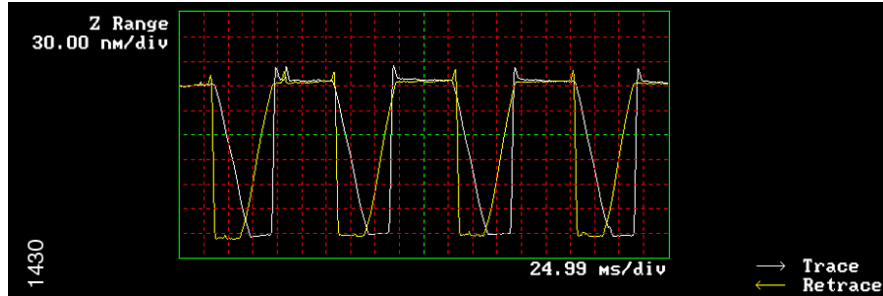
Set this parameter so that the smallest amount of force is applied during scanning while still maintaining a stable engagement on the surface.

If the setpoint is too close to the free air amplitude (TappingMode) or free air deflection (Contact Mode) of the cantilever, the tip will not trace the topography properly.

This problem will be more pronounced on downward slopes with respect to the scan direction. An example of this is shown below.



**Figure 16.1a** Scope Trace Demonstrating the Effect of the Setpoint Being Adjusted Too Close to the Free Air Amplitude During TappingMode AFM



Notice that the tip tracks the surface up the sidewall properly but not down the sidewall with respect to the scan direction. This occurs on opposite sides of features for the Trace and Retrace scan directions.

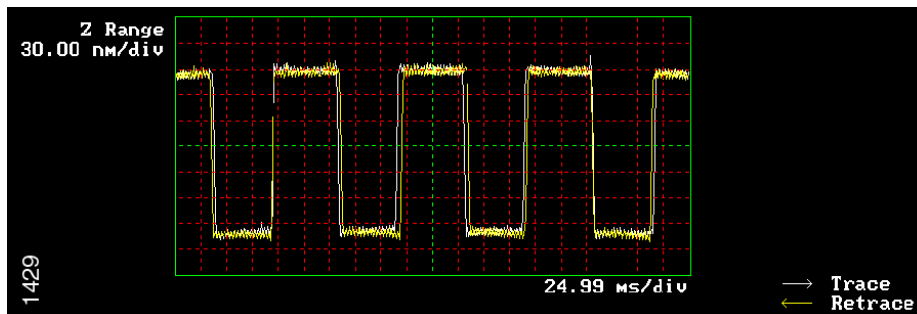
This problem can be remedied by decreasing the Setpoint in TappingMode, or increasing the Setpoint in Contact Mode.

## 16.2 Integral Gain

The Integral Gain controls the amount of the integrated error signal used in the feedback calculation. The higher this parameter is set, the better the tip will track the sample topography.

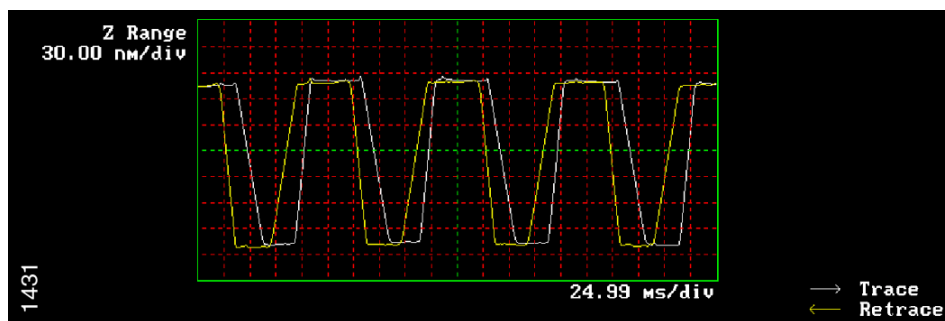
However, if the integral gain is set too high, noise due to feedback oscillation will be introduced into the scan, as shown below.

**Figure 16.2a** Scope Trace Demonstrating the High Frequency Noise that Occurs when the Integral Gain is Set Too High



Setting the integral gain too low may result in the tip not tracking the surface properly, as shown below.

**Figure 16.2b** Scope Trace Demonstrating the Effect of Setting the Integral Gain Too Low



Set the Integral Gain as high as possible by increasing the gain until noise is seen, then reduce the gain just lower than the value where the noise disappears.

### 16.3 Scan Rate

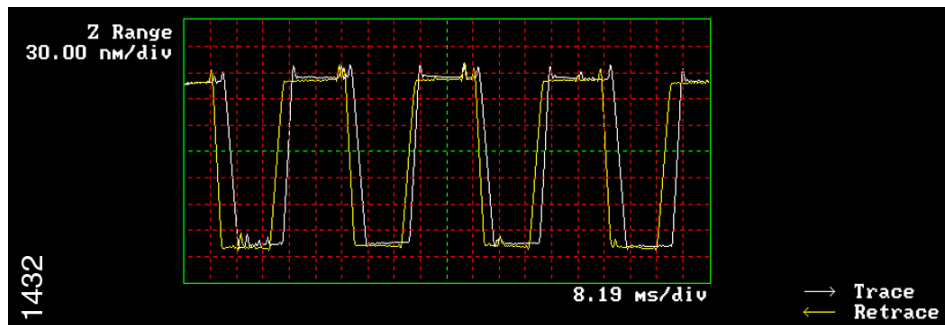
The Scan Rate is the number of trace and retrace scan lines performed per second (Hz).

- For example, with a scan rate set to 1Hz, the tip will scan forward and back (trace and retrace) in 1 second.

Set this value so that the feedback loop has time to respond to changes in the sample topography.

Setting the scan rate too high will result in poor tracking of the surface, as shown below.

**Figure 16.3a** Scope Trace Demonstrating the Effect of Setting the Scan Rate Too High



The actual *tip speed* or of the tip depends on two parameters: **Scan Rate** and **Scan Size**. Since the Scan Rate units are lines per second (Hz), increasing the Scan Size without changing the Scan Rate actually increases the scan velocity of the tip.

- For example, if the Scan Rate is 1Hz and the Scan Size is 1 $\mu$ m, the scan velocity is 2 $\mu$ m/sec (since it performs the trace and retrace scans in 1 sec). By increasing the Scan Size to 100 $\mu$ m, the scan velocity increases to 200 $\mu$ m/sec if the Scan Rate remains 1Hz.

The Scan Rate setting will greatly depend on the scan size and the height of the features being imaged. In general, the taller the features and/or the larger the scan size, the slower the scan rate.

Typical Scan Rate settings are 0.5 to 2.0Hz for TappingMode and 1 to 4Hz for Contact Mode.

## 16.4 Other Important Parameters

**Scan Size:** Adjusts the size of the X,Y scan area

**X Offset, Y Offset:** Translates the scan area in X and Y directions without changing scan size

**Note:** The **Zoom** and **Offset** commands found on the display monitor may also be used to change the scan size and X and Y offsets.

**Scan Angle:** Controls the angle of the fast scan direction of the scanner with respect to the X axis

**Samples/line:** Determines the number of data points or pixels in X and Y (128, 256, or 512)

**Slow Scan Axis:** Enables and Disables movement of the scanner in the direction of the slow scan axis. (Y direction at 0° Scan Angle)

**Proportional Gain:** Controls the amount of proportional error signal used in feedback calculation. Typically set 30 to 100% higher than the Integral Gain

**Data Type:** Selects the signal viewed on the display monitor - this parameter is set to Height for topographical measurements

**Line Direction:** Selects the direction of the fast scan during data collection: Trace (left to right) or Retrace (right to left).

**Microscope Mode:** Sets mode of operation to Tapping, Contact, or Force Mod

**Data Scale:** Controls the vertical scale of the full height of the display and color bar. This parameter does not effect the Realtime operation of the microscope, only the expansion and contraction of the color scale.

**Z-limit:** Allows the 16 bits of the digital-to-analog converters to be applied to a smaller vertical range. This has the effect of increasing the vertical sampling resolution and should be used for imaging very smooth surfaces (<5nm RMS) or performing atomic resolution.

- For example, a Dimension or J MultiMode scanner may have a full vertical movement of 6 $\mu$ m over 440V. By reducing the Z-limit to 55V, the full vertical movement of the scanner is reduced to 0.75 $\mu$ m over the same 16 bits. Therefore, the vertical sampling size becomes smaller, which increases the Z resolution.

**Note:** Do not reduce the Z-limit if there is a chance that a feature will exceed the reduced vertical range.

**Z-Center Position:** The Z-center voltage scale is located to the right side of the image on the display monitor. It represents the current extension or retraction of the Z piezo electrode of the scanner during operation.

- It is displayed from -220V to +220V (440V full range) which represents the entire vertical travel of the scanner (i.e. 5 to 6 $\mu$ m for a Dimension scanner or J MultiMode scanner).
- It is recommended that the Z-Center Position be kept as close to 0V as possible when making height measurements. The Z-Center Position is adjusted by using Step Motor in the Motor menu.
- Images which are saved in Offline and are being acquired in Realtime are all referenced to a Z-Center Position of 0V, which is the middle of the overall vertical movement. In other words, when the system shows you an image, it centers the data at a Z-Center Voltage value of 0V. Therefore, if the data is captured at an average value of 100V, a Z offset of 100V will have to be removed from the image in order to observe the data. This can be offset in Realtime and Offline by the **Realtime Planefit** and **Offline Planefit** parameters, respectively.

**Realtime Planefit:** The setting of this parameter only effects how the image is viewed in Realtime. It has no effect on how the data is saved.

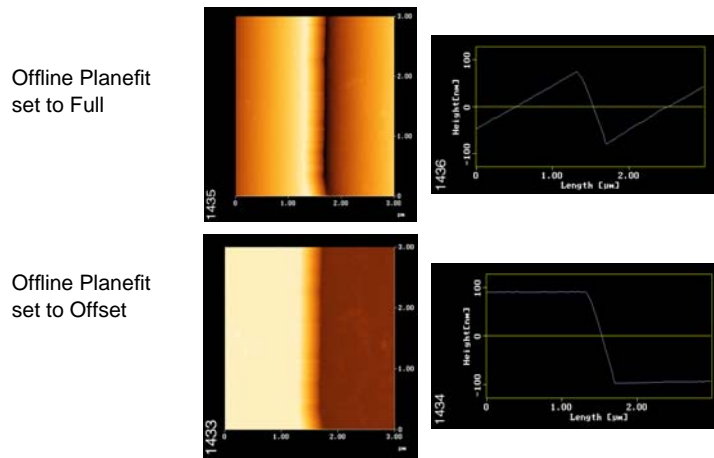
- **Line:** Removes tilt by applying a first-order planefit and removes the Z offset from every line scan individually in the fast scan direction (X direction at 0°) during scanning. This is essentially the same as performing a first-order Flatten (see Offline Analysis). This setting is commonly used for everyday imaging.
- **Offset:** Does not remove the tilt from the scan lines, but does calculate and remove the Z offset from each scan line individually. This setting is useful if you need to view the tilt in the sample in Realtime
- **None:** Does not remove the tilt or the Z offset from the image. This setting is not generally recommended.

**Offline Planefit:** Controls whether the images are saved with or without tilt correction. There are two primary choices:

- **Full:** Applies a first order planefit (explained in Offline Analysis) to the image in X and Y and removes the Z offset before the image is saved.
- **Offset:** Saves the image without removing the tilt with a first order planefit, but does remove the Z offset.
- **None:** Saves the image without removing the tilt or the Z offset.

The Full setting is commonly used for everyday imaging. However, the Offset setting can be useful when a first order plane fit would negatively affect the measurement of interest. This can be demonstrated in the example below. If the measurement of interest is the height of the step, then setting the Offline Plane fit to Full will result in the tilting of the data. However, if the Offline Plane fit is set to Offset, then a plane fit is not applied and the step orientation is not altered. If the Full setting were applied, a first order plane fit could be applied in the Offline software to reorient the features without negatively affecting the measurement.

**Figure 16.4a** Step Measurement Demonstrating the Effect of the Offline Plane fit Parameter.



## 17.0 Force Curves

Force curves are commonly used to set the imaging force in contact mode and to study attractive, repulsive, and adhesive interactions between the tip and the sample.

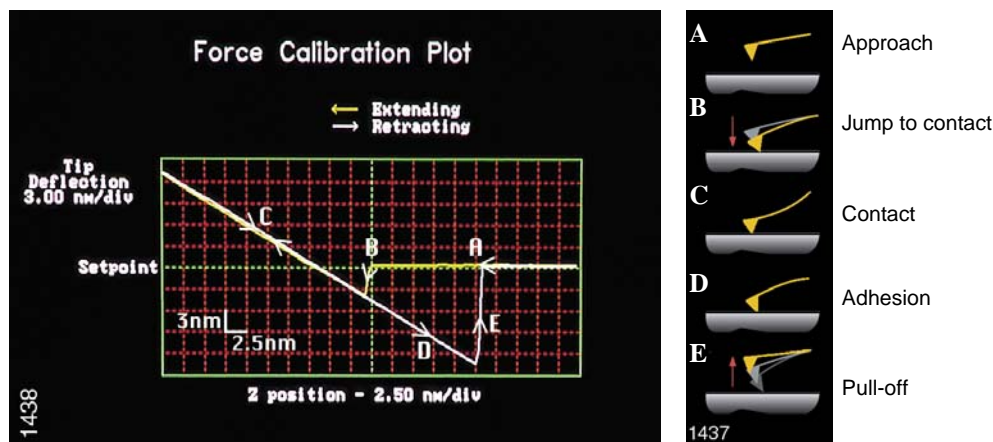
The Realtime menu for obtaining force curves is found under **View > Force Mode > Calibrate**.

When a force curve is acquired, the lateral (X and Y) movement of the scanner is stopped, and the scanner extends and retracts the Z electrode of the scanner.

- For the MultiMode AFM, the sample is moved with respect to a stationary tip, and with the Dimension and BioScope AFMs, the tip is moved with respect to a stationary sample.

A force curve plots the deflection of the cantilever as it contacts and separates from the sample during the extension and retraction of the scanner.

**Figure 17.0a** Typical Force Curve with Schematic Labeling Corresponding Tip-Sample Interaction Points



On the force curve graph, the distance of the scanner movement is represented by the *horizontal* axis, and the cantilever deflection is represented by the *vertical* axis.

Primary parameters for obtaining a force curve include:

- **Z-scan start:** Defines the starting point of the scanner movement within the overall Z scan range.
- **Ramp size:** Vertical scanner movement distance.
- **Setpoint:** Used to set the imaging force. This is the same parameter as the **Setpoint** in **Image Mode**.

The imaging force may be set by using the Setpoint parameter to determine where the sloped portion of the curve (points C & D) intersects the green, horizontal Setpoint line in the center of the graph.

- The force may be calculated by Hooke's Law,  $F = -kx$ , where  $F$  = force,  $k$  = spring constant, and  $x$  = deflection. See your microscope's manual for further instruction.

Force curves may also be acquired in TappingMode to view the change in amplitude and phase with tip-sample separation. Care should be taken not to completely dampen the oscillation, since this may result in damaging the tip.

## 18.0 Offline Operation

### 18.1 File Handling

Once images are captured during Realtime operation, they are viewed and measured with the Offline commands. Here we will touch on a few of the basic operations and functions.

- Each captured image is immediately stored in the Capture directory in Offline.
- Access to different disk drives is available at the top of the file directory panel. The !:\ drive is the Capture directory, the A:\ drive is a floppy drive, the C:\, D:\ and E:\ are usually the computer hard drives. If the system has additional drives, they are set through Z:\.
- The data management commands are found in the **File** pull down menu. This menu contains the **Move**, **Copy**, **Delete**, **Rename**, and **Create Directory** commands for transferring data between directories.
- The **Browse** command, also under the **File** menu, places up to twenty-four images on the screen with a variety of commands available at the top of the **Browse** screen. There is also a **File** menu within the **Browse** commands which provides the ability to specify in any order which images to **Move**, **Copy**, **Delete**, or **Rename**. Browse also provides the ability to view two images side-by-side by using **Dual**, or to view up to six images side-by-side using **Multi**.

### 18.2 Image Analysis

A wide variety of analysis functions are available in the **Analyze** menu in the Offline for measuring captured SPM images.

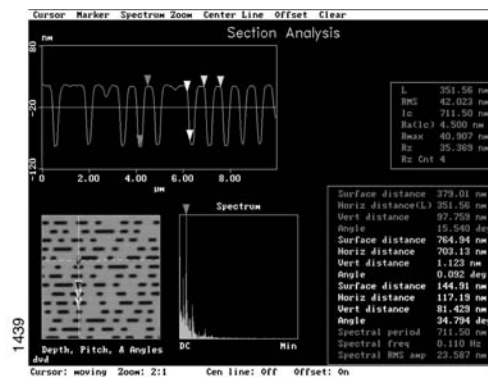
Each of the analysis routines is useful and described in detail in the Command Reference Manual. Some of the most commonly used analysis routines are briefly described below.

#### Section

Depth, height, width, and angular measurements can be easily made with Section. For an example, see [Figure 18.2a](#).



**Figure 18.2a** Cross-Sectional Measurement on a DVD Replica Disk



A cross-sectional line can be drawn across any part of the image, and the vertical profile along that line is displayed. The Cursor menu located at the top of the Display monitor provides the ability to draw a fixed, moving, or averaged cross section.

Up to three pairs of cursors may be placed on the line section at any point to make horizontal, vertical, and angular measurements. These measurements are reported in the box at the lower right of the screen. Cursors may be added or deleted with the Marker menu located at the top of the Display monitor. The measurements are displayed in the same colors as the corresponding markers.

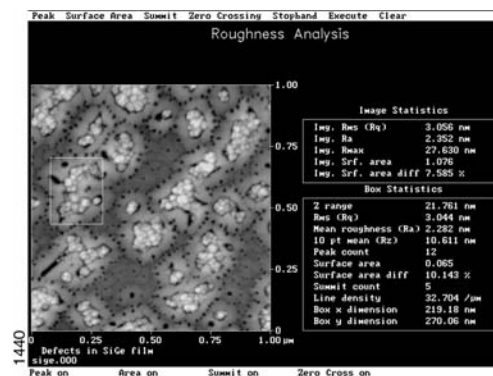
The power spectrum (fast Fourier transform (FFT)) along the cross section is displayed in the lower center window. The cursor may be used to determine the predominate periodicities along the cross section by placing it at peaks in the spectrum.

The roughness measurements of the portion of the cross section between the two colored cursors are displayed in the window in the upper right.

## Roughness

Roughness measurements can be performed over an entire image or a selected portion of the image with **Roughness**.

**Figure 18.2b** Roughness Measurements on Epitaxial SiGe Image Showing Growth Defects



There are a wide variety of measurements made in Roughness. The roughness parameters which are displayed are chosen under the Screen Layout menu.

The measurements made on the entire image are displayed under “Image Statistics.” Roughness measurements of a specific area may be determined by using the cursor to draw a box on the image. After selecting “Execute,” the measurements within the selected area are displayed under “Box Statistics.”

The most common measurements are the following:

1. **RMS (Rq):** The Root Mean Square (RMS) Roughness is the standard deviation of the Z values within a given area.

$$\text{RMS} = \sqrt{\frac{\sum_{i=1}^N (Z_i - Z_{\text{ave}})^2}{N}}$$

- $Z_{\text{ave}}$  is the average Z value within the given area,  $Z_i$  is the current Z value, and N is the number of points within a given area.
- **R<sub>a</sub>:** The Mean Roughness ( $R_a$ ) represents the arithmetic average of the deviations from the center plane.

$$R_a = \frac{\sum_{i=1}^N |Z_i - Z_{\text{cp}}|}{N}$$

- $Z_{\text{cp}}$  is the Z value of the center plane, and  $Z_i$  is the current Z value, and N is the number of points within a given area.

**Note:** The above equations for RMS and  $R_a$  are presented for ease in understanding. The formulas used by the NanoScope software to compute these numbers are found in the manual.

2. **R<sub>max</sub>:** The difference in height between the highest and lowest points on the surface relative to the Mean Plane
3. **Surface Area:** The three-dimensional area of a given region. This value is the sum of the area of all of the triangles formed by three adjacent data points.
4. **Surface Area diff:** The percentage increase of the three dimensional surface area over the two dimensional surface area.

## Bearing

Bearing ratio determination and depth histogram measurements are possible with Bearing.

Bearing provides a method to analyze how much of the surface lies below or above a given height. The “bearing ratio” of the surface is the percentage of the surface at a specific depth with respect to the entire area analyzed. (See manual for further description)

The depth histogram plots depth versus percentage of occurrence of data at different depths.

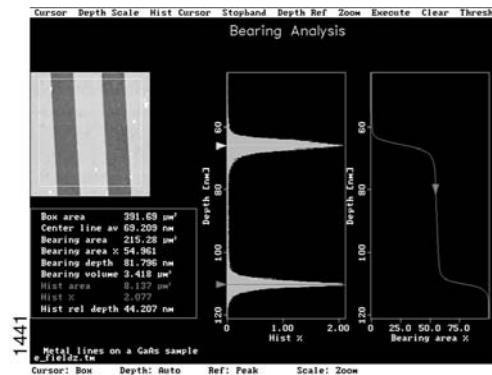
By enabling the Histogram Cursor (top menu, display screen), two cursors are available on the histogram to make relative depth measurements.

Area depth measurements can be made by placing the two cursors at peaks representing different feature heights. The area depth measurement can be made by determining the relative depth between the two cursors.

- Planefit and/or Flatten may need to be performed before making this measurement. This will produce sharper peaks in the depth histogram.

The **Depth** feature may be used to make automated depth histogram measurements over many images. (See manual for details)

**Figure 18.2c** Area Depth Measurement of GaAs Lines using the Bearing Histogram



## 18.3 Filters

There are a wide range of modification functions found in the Modify menu that may be applied to an image once it has been captured. These functions are explained in detail in the Command Reference Manual.

It should be kept in mind that by using any modification functions, the data is being changed which may or may not affect the measurements of interest. In general, it is good practice to modify the image as little as possible, and to understand how the applied function will affect the image and measurements.

## Flatten

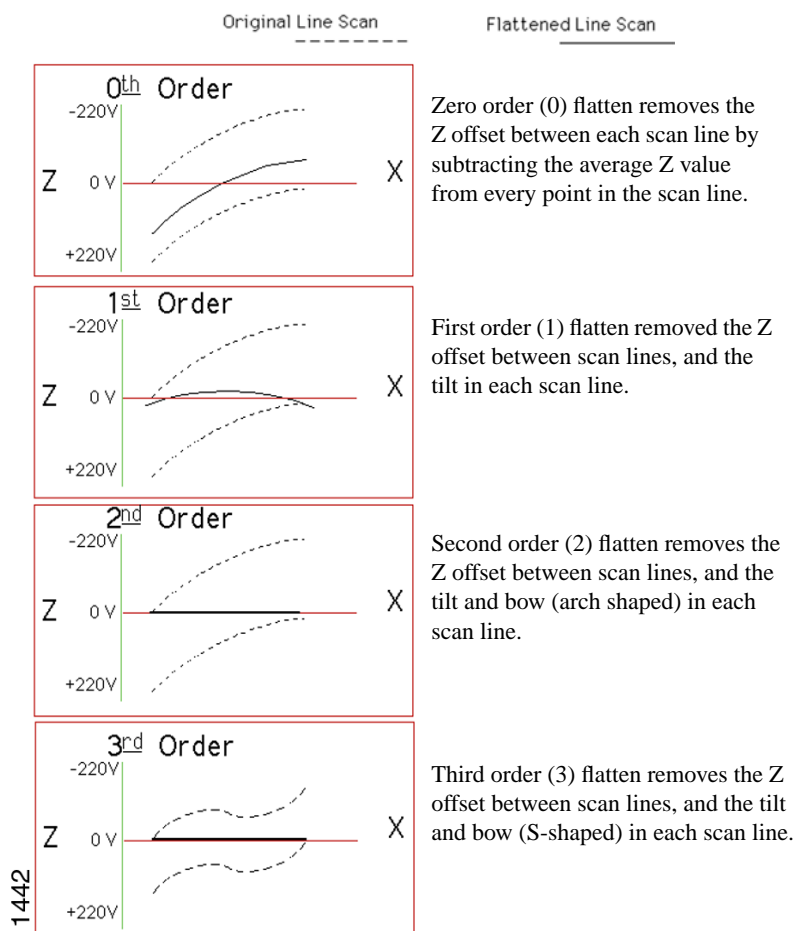
Flatten may be used to remove image artifacts due to vertical (Z) scanner drift, image bow, skips, and anything else that may have resulted in a vertical offset between scan lines.

Flattening modifies the image on a **line-by-line** basis. It consists of removing the vertical offset between scan lines in the fast scan direction (X at 0° scan angle) by calculating a least-squares fit polynomial for a scan line, and subtracting the polynomial fit from the original scan line.

- This has the affect of making the average Z value of each scan line equal to 0V out of the +/- 220V z-range.

Flattening can be performed by applying a 0th, 1st, 2nd, or 3rd order polynomial fit to each scan line.

**Figure 18.3a** Schematic Showing the Effects of Flattening Order on Two Scan Lines in X Acquired at Different Locations in Y in the Image

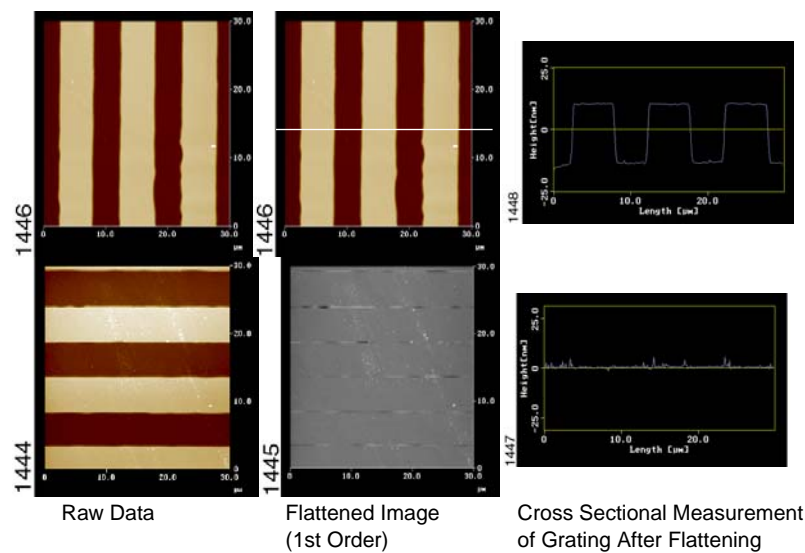


Flattening is a powerful filter which you may or may not use often. However, it is important to understand how flattening can effect subsequent measurements.

Since the vertical offset between each line scan is being removed, this has the effect of removing the information in the Y direction.

- When applying flatten on very smooth surfaces, this has a negligible effect on the roughness measurements.
- If you are interested in measuring feature heights, it is best to scan across these features in the fast direction, so that if you need to perform a flatten, it does not adversely affect your measurements. An example of this is shown below.

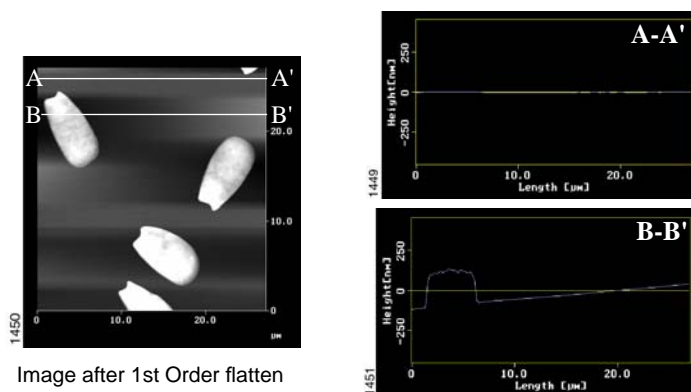
**Figure 18.3b** The Effect of Flattening on Image Measurements



It can be seen from the above example that in order to make accurate cross sectional measurements on the grating after flattening, the structures should be oriented so that they are scanned in the fast scan direction (at a  $0^\circ$  scan angle, this is the X scan direction). If the features of interest are not oriented perpendicular to the fast axis, this may require rotating the scan with the Scan Angle parameter, or rotating the sample.

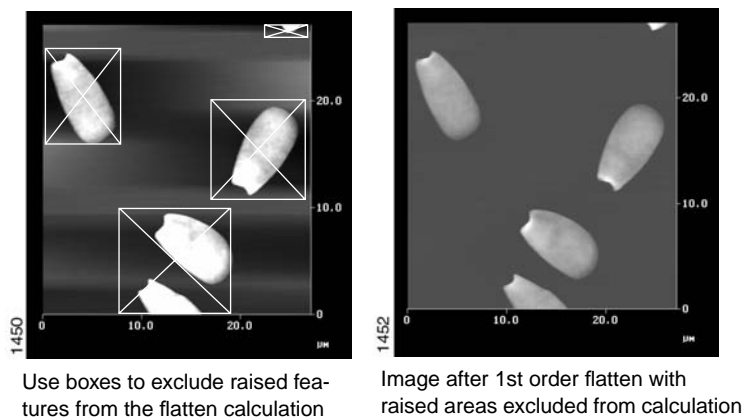
Flattening an image which consists of a flat plane with “bumps” or “pits” on it will result in the flat area next to the features (along the X direction) to appear lower with respect to the flatten scan lines without raised or depressed features. An example of this is shown below.

**Figure 18.3c** Cross sections on first order flattened image of cells on a smooth glass substrate showing how flattening can cause the distortion of the plane next to a raised feature in the fast direction



This problem can be remedied by excluding the raised or depressed features from the flatten calculation by drawing boxes around them with the cursor before executing the flatten.

**Figure 18.3d** Flattening an AFM Image of Cells on a Smooth Glass Substrate Using the Boxes to Exclude the Cells from the Flattening Calculation



### Planefit Auto

Planefit is commonly used to remove tilt or bow from images.

Planefit calculates a single polynomial fit for the entire image and then subtracts the polynomial fit from the image.

Planefit may be applied by calculating a 1st, 2nd, or 3rd order polynomial fit to the image in the X or Y directions.

- 1st order planefit removes tilt
- 2nd order planefit removes tilt and an “arch-shaped” bow
- 3rd order planefit removes tilt and an “S-shaped” bow

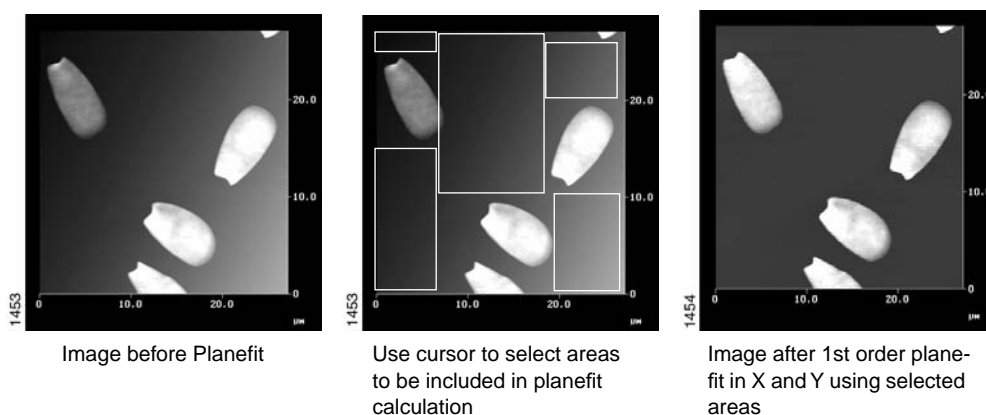
Extreme variations in the sample topography can alter the plane fit, leaving a slight tilt in the image.

This can be remedied by only selecting flat portions of the image to determine the plane fit. The calculation is performed only using the chosen areas, and the plane fit is extrapolated on to rest of the image.

The areas are chosen to be part of the plane fit calculation by drawing a box or boxes on the image. An example of this is shown below.

Examples of 2nd and 3rd order bow removal can be seen in the Typical Image Artifacts section of this manual.

**Figure 18.3e** 1st Order Plane fit using Selected Areas of AFM Image of Cells on a Smooth Glass Substrate



### Other Commonly Used Filters

**Plane fit Manual:** Similar to Plane fit Auto except that the plane fit is calculated from a manually positioned line drawn across the image in X and/or Y.

**Erase Scan Lines:** Removes scan lines from image due to skips, noise, etc. This routine replaces the selected scan line with the average of the two scan lines adjacent to it.

**Zoom:** Expands a selected portion of the captured image to fill the display screen.

**Note:** This does not increase the resolution or fine detail of the captured image.

**Lowpass:** Removes high frequency data from the image by replacing each data point with a 3x3 weighted average of points surrounding each point. This feature may be useful for removing noise if the gain settings were set too high or if the SPM was in a noisy environment when the image was captured.

**Spectrum 2D:** Two-dimensional fast Fourier transform (2D FFT) filter which allows the inclusion or removal of specific spatial frequencies (or wavelengths) from the image.

### **Utility Commands**

The **Utility** pull down menu provides the ability to output (and input) data in various forms.

**Print** will send whatever is currently on the Display monitor to a printer. This may also be accomplished at any time (in Realtime and Offline) by hitting the Print Screen button at the top of the keyboard.

Data may also be exported (and imported) as TIFF and ASCII files for use with other software programs.

Automated Offline analysis may be performed with the **Auto Program File** feature. This provides the capability to perform a series of modification and analysis routines to many images, storing the result in the **Auto Result File**.



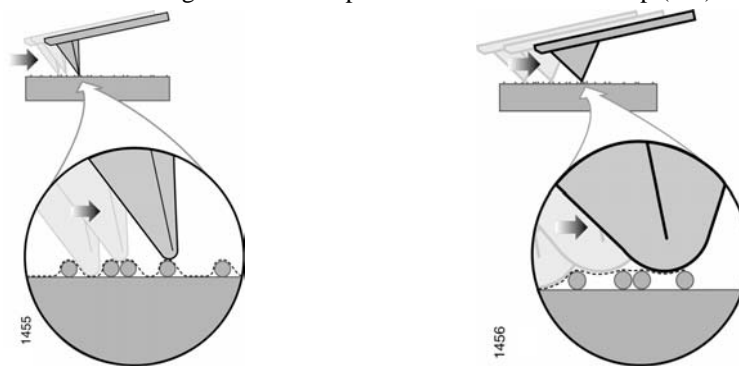
## 19.0 Tip Shape Issues

The SPM image is a result of the interaction of the tip shape with the surface topography.

There are two primary features of the tip which affect the SPM image: the radius of curvature and the tip sidewall angles.

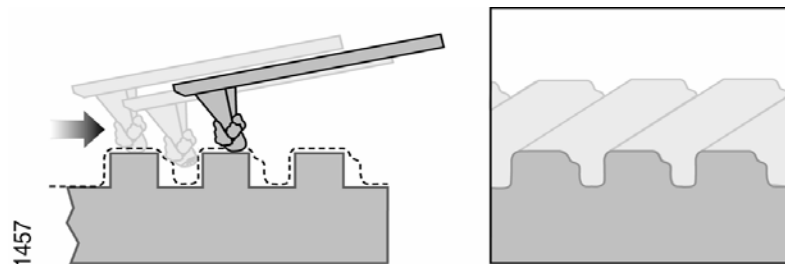
The smaller the radius of curvature, the smaller the feature that can be resolved. A sharper tip will be able to laterally resolve smaller features than a dull tip with a larger radius of curvature. This can be seen in the example below.

**Figure 19.0a** Schematics and Image Profiles of Spheres Scanned with a Sharp (left) and Dull (right) Probe



The accumulation of debris on the end of the tip can also dull the tip and result in image distortion, as shown below.

**Figure 19.0b** Schematic and Image Profile of Trenches Scanned with a Dirty Tip



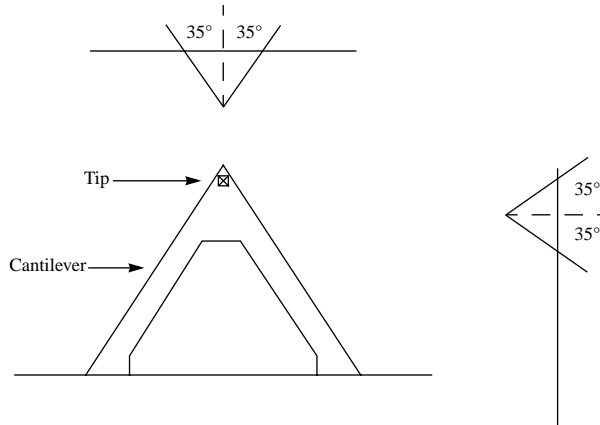
**Note:** A dull or dirty tip may not affect the measurement of the vertical dimensions of these samples.

---

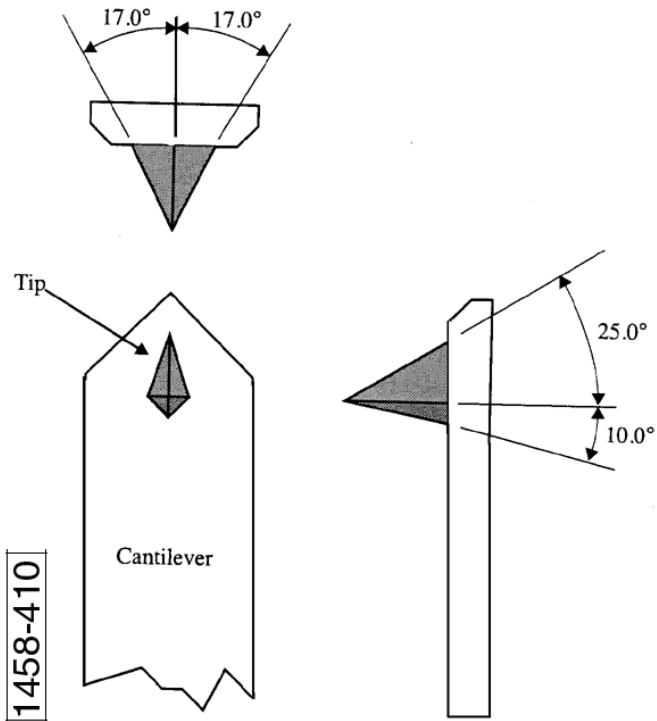
# Tip Shape Issues

---

Tip Sidewall Angles of Silicon Nitride Probes



Tip Sidewall Angles of Etched Silicon Probes



The ability to image steep sidewalls on a sample surface is determined by the sidewall angles of the tip.

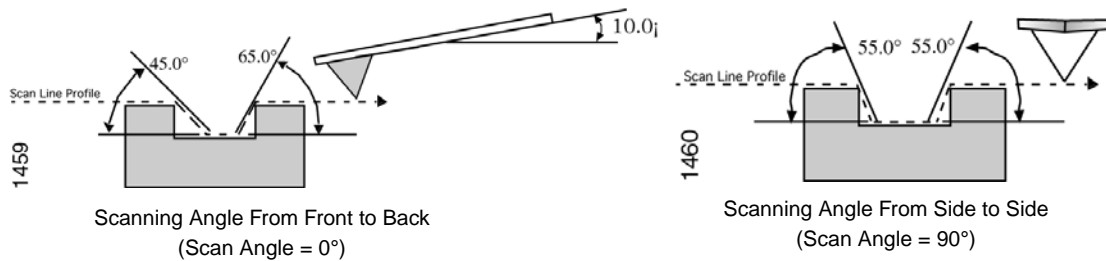
The tip is not able to profile sides of surfaces steeper than the sidewall angle of the tip.

- When scanning across features which are steeper than the sidewall angle of the tip, the sidewall angle in the images will reflect the sidewall angle of the tip.

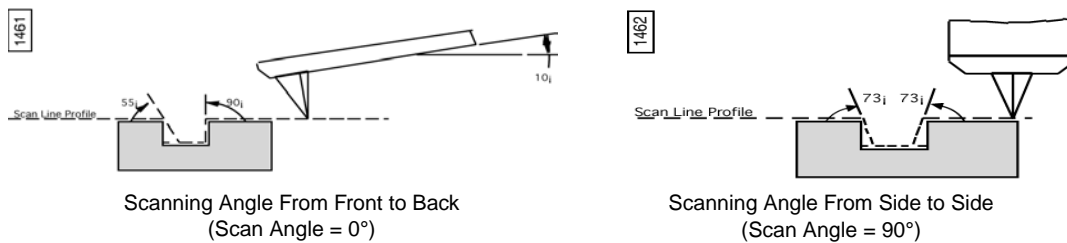
The following examples show the resulting angles and image profiles of silicon nitride and silicon tips scanned over trenches with 90° sidewall angles.

The tip is mounted in the cantilever at ~10°, so the angles measured with the front and back sides of the tip will be skewed by ~10°.

**Figure 19.0c** Sidewall Angle Measurements of Trench with Vertical Sidewalls Acquired with Silicon Nitride Probe



**Figure 19.0d** Sidewall Angle Measurements of Trench with Vertical Sidewalls Acquired with Silicon Probe



## 19.1 Resolution Issues

The resolution of AFM images can be thought of in terms of *lateral (X,Y)* resolution and *vertical (Z)* resolution.

### Lateral Resolution Issues

#### Tip Shape:

- As discussed in the previous section on tip shape effects, the radius of curvature of the end of the tip will determine the highest lateral resolution obtainable with a specific tip. The sidewall angles of the tip will also determine its ability to probe high aspect ratio features.

#### Pixelization:

- The **Samples/ line** parameter in the Realtime menu determines the number of data points present in the image in the X and Y scan direction. These data points are commonly called “pixels.” Available choices are 512, 256, and 128.
- Pixelization affects resolution in that you cannot resolve features smaller than the pixel size of the image.
- For example, if you are acquiring a 50 $\mu\text{m}$  x 50 $\mu\text{m}$  image with the **Samples/ line** parameter set to 512, then the pixel size is 98nm (50 $\mu\text{m}$ ÷512=0.098 $\mu\text{m}$  or 98nm). Thus, you will not be able to resolve features smaller than 98nm at a 50 $\mu\text{m}$  scan size.
- If you want to be able to see 10nm sized features, you will need to choose a scan size <5.12 $\mu\text{m}$  (preferably 1 or 2 $\mu\text{m}$ ) since 5.12 $\mu\text{m}$ ÷512 = 0.010 $\mu\text{m}$  or 10nm.
- Regardless of the pixel size, the feedback loop is sampling the topography many times at each pixel. The data displayed at each pixel is the average of the sampling iterations by the feedback loop over the pixel area.

### Vertical Resolution Issues

#### Scanner:

- Since the resolution in the vertical direction is not determined by the tip shape, it is primarily determined by the resolution of the vertical scanner movement which is  $<1\text{\AA}$ .

#### Pixelization:

- As in the lateral dimension, the number of data points in the vertical direction limits the size of the smallest resolvable height change.
- The number of data points in the vertical dimension is determined by the conversion of 16 bits over the full vertical range of the scanner (440V).
- The Z-limit parameter may be used to increase the sampling resolution in the vertical dimension to image sub-angstrom height changes with large Z range scanners.

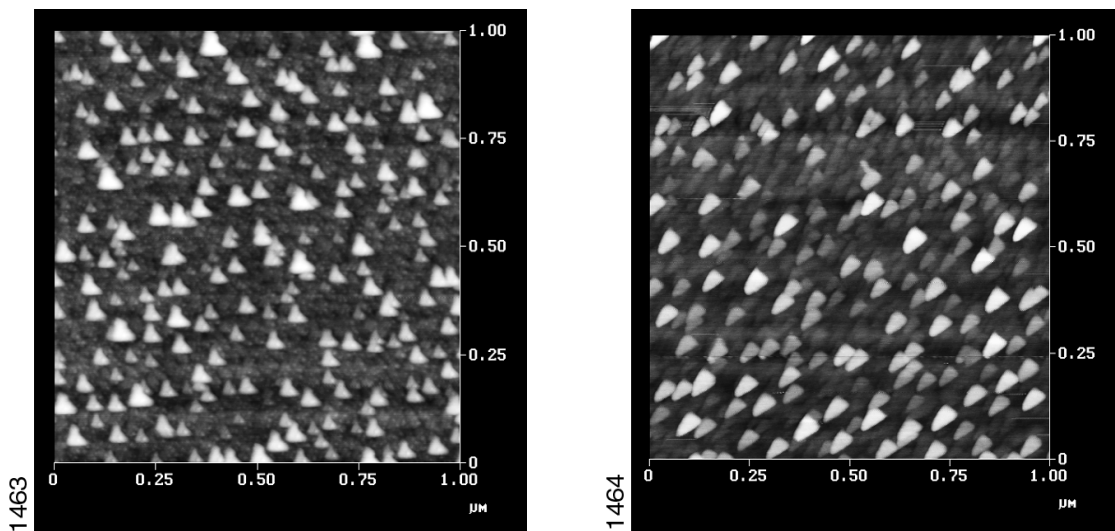
#### Noise:

- The overall system noise will generally be the primary limiting factor in the highest obtainable vertical resolution that can be acquired with your SPM. This may be a result of combined effects from electrical, mechanical, and acoustic noise sources.
- Veeco Instruments guarantees 0.3 to  $\sim 1\text{\AA}$  RMS noise levels depending on the type of SPM and SPM environment.

## 20.0 Typical Image Artifacts

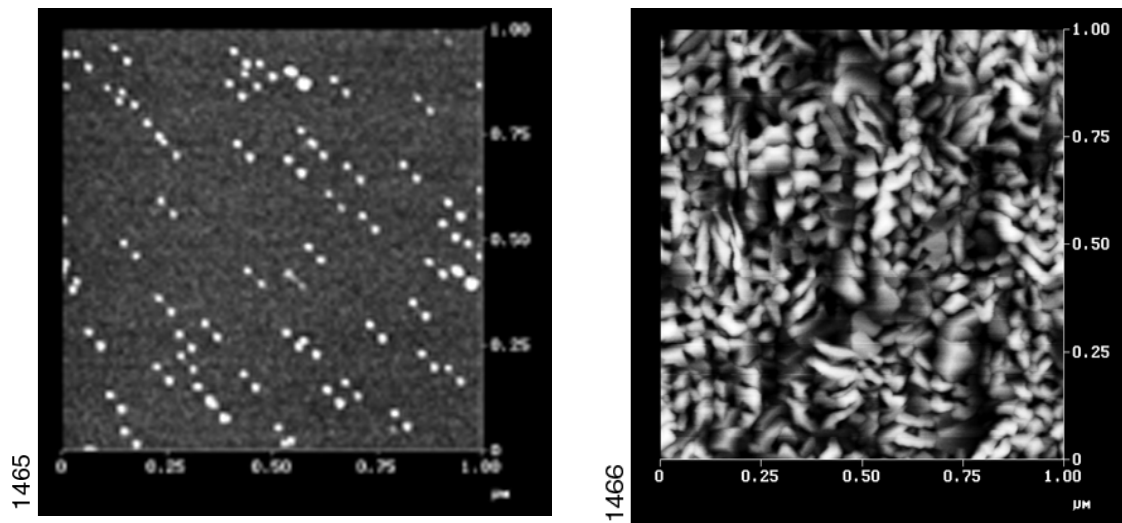
If the tip becomes worn or if debris attaches itself to the end of the tip, the features in the image may all have the same shape. What is really being imaged is the worn shape of the tip or the shape of the debris, not the morphology of the surface features (see [Figure 20.0a](#)).

**Figure 20.0a** Dull or Dirty Tip



Double or multiple tip images are formed with a tip with two or more end points which contact the sample while imaging. The above images are examples (see [Figure 20.0b](#)).

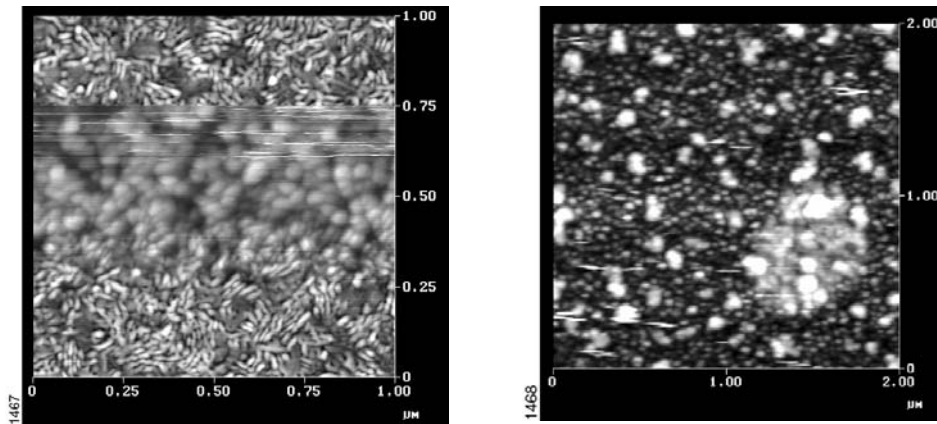
**Figure 20.0b** Double or Multiple Tips



Loose debris on the sample surface can cause loss of image resolution and can produce streaking in the image. The image on the left is an example of the loss of resolution due to the build up of contamination on the tip when scanning from bottom-to-top. It can be seen how the small elongated features become represented as larger, rounded features until the debris detaches from the tip near

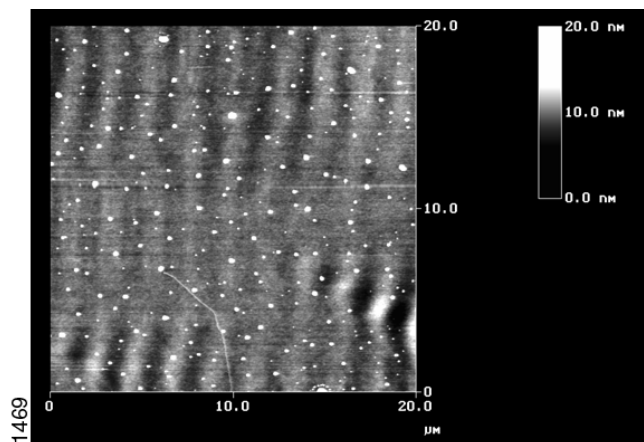
the top of the scan. The image on the right is an example of skips and streaking caused by loose debris on the sample surface. Often, loose debris can be swept out of the image area after a few scans, making it possible to acquire a relatively clean image. Skips can also be removed from a captured image with the Erase Scan Lines function (see [Figure 20.0c](#)).

**Figure 20.0c** Contamination from Sample Surface



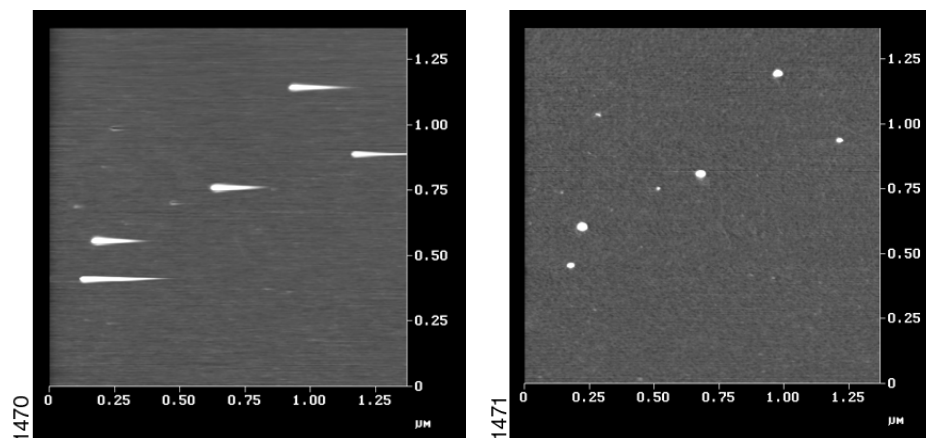
Interference between the incident and reflected light from the sample surface can produce a sinusoidal pattern on the image with a period typically ranging between 1.5-2.5 $\mu\text{m}$ . This artifact is most often seen in contact mode on highly reflective surfaces in force calibration plots and occasionally in TappingMode images. This artifact can usually be reduced or eliminated by adjusting the laser alignment so that more light reflects off the back of the cantilever and less light reflects off the sample surface, or by using a cantilever with a more reflective coating (MESP, TESPA) (see [Figure 20.0d](#)).

**Figure 20.0d** Optical Interference



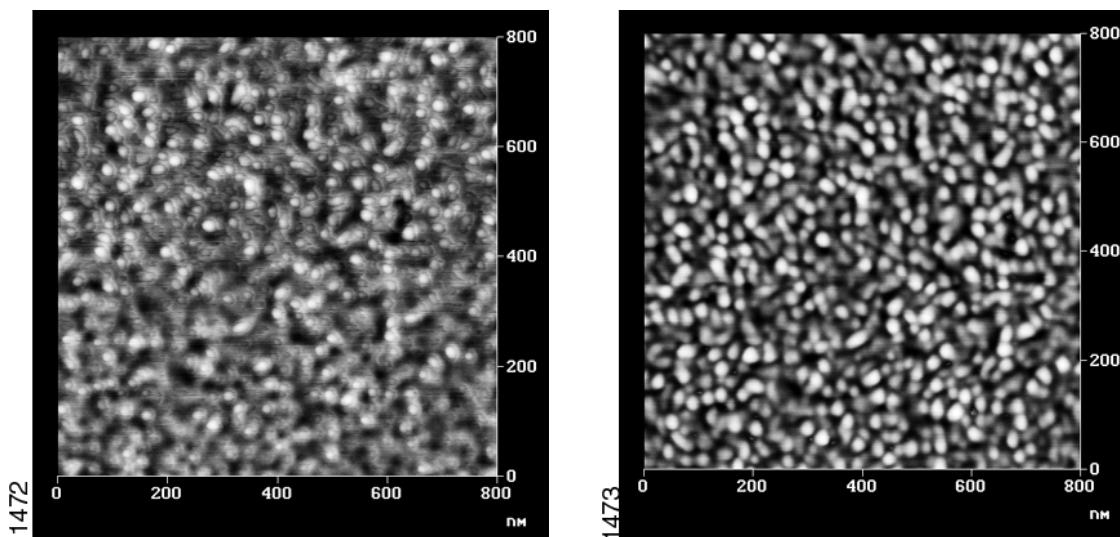
When the feedback parameters are not adjusted properly, the tip will not trace down the back side of the features in TappingMode. An example of this can be seen in the image on the left which as scanned from left-to-right (trace) producing “tails” on the colloidal gold spheres. The image on the right is the same area imaged with a lower setpoint voltage, increased gains, and slower scan rate (see [Figure 20.0e](#)).

Figure 20.0e Not Tracking



In TappingMode, when operating on the high frequency side of the resonance peak, rings may appear around raised features which may make them appear as if they are “surrounded by water.” An example of this can be seen in the image of the Ti grains on the left. Decreasing the Drive Frequency during imaging can eliminate this artifact, as shown in the image on the right (when reducing the Drive Frequency, the Setpoint voltage may need to be reduced as well) (see [Figure 20.0f](#)).

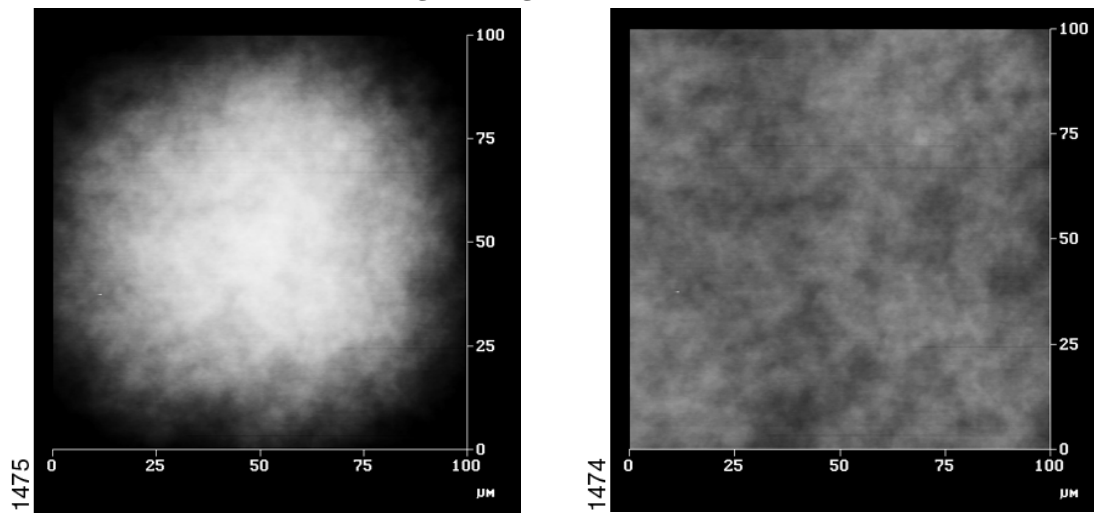
Figure 20.0f Rings During High Frequency Operation



The arch shaped bow in the scanner becomes visible at large scan sizes (left). The bow in this image can be removed by performing a 2nd order Planefit in X and Y (right). (Data Scale = 30nm) (see [Figure 20.0g](#))

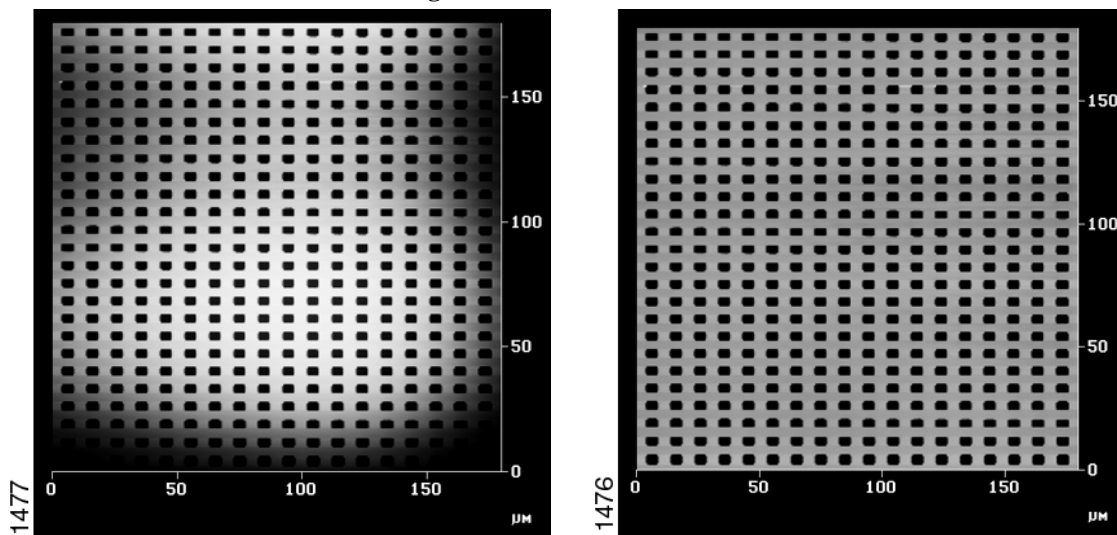


**Figure 20.0g** 2nd Order Bow



At large scan sizes, the bow in the scanner may take on an S-shaped appearance (left). This may be removed by performing a 3rd order plane fit in X and Y (right). (Data Scale = 324nm) (see [Figure 20.0h](#)).

**Figure 20.0h** 3rd Order Bow



## 21.0 Calibration

**Note:** This section is meant to introduce the NanoScope user to basic Calibration procedures. For a more detailed discussion, please consult your specific equipment manual. Please refer to your standard for step height information.

As described earlier in this manual, the sensitivity of the scanner decreases exponentially with operation time. This will result in inaccurate dimensional measurements in the AFM image if this is left uncorrected.

It is recommended that the X, Y, & Z calibration of the AFM be checked at least every 3 months during the first year of operation and every six months thereafter.

This may be accomplished by imaging the 10 $\mu$ m x 10 $\mu$ m pitch grating with 200nm deep pits that is supplied with the instrument. The 1 $\mu$ m x 1 $\mu$ m grating may be used for calibrating X & Y for small range scanners.

Check that the spacing of the pits is the same throughout the scan at the largest scan size (440V). This can be easily done using the Zoom box.

- If the spacing is not consistent, go to **Microscope > Calibrate > Scanner** and adjust the Fast Mag and Fast Arg parameters for correction in the X direction, and the Slow Mag and Slow Arg parameters for correction in the Y direction. (see manual for instructions)

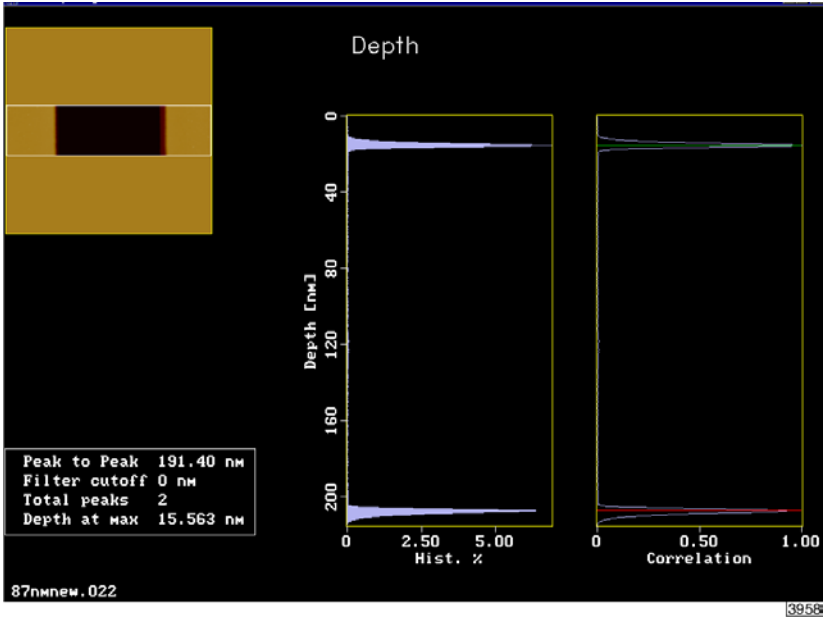
Check the dimensions in X & Y at scan sizes of 440V and 150V to see if the pitch measurement falls within 2% (10 + 0.2 $\mu$ m).

- If this needs correcting, run the automated calibration routine found under **Capture > Capture Calibration**. This routine captures twelve images at various scan sizes and settings to calibrate the scanner sensitivity, sensitivity change with scan size, and scanner rotation. The operator should watch the capture of the first four images in case the microscope needs adjustment.
- Once the images are acquired, go to **Utility > Autocalibration** in the Offline menu. This routine will bring up each of the images and tell you to draw a vertical or horizontal line along the pits. The computer will display what it thinks the distance of the line is and the operator enters the distance according to the pitch of the pits. This will calculate new sensitivity, derating, and coupling parameters in the **Microscope > Calibrate > Scanner** menu.

Check the Z calibration by scanning the same 10 $\mu$ m x 10 $\mu$ m pitch grating as used in the X and Y calibration. The pits in this grating have a depth of 200nm.

- Capture an image which contains a single pit. Make sure that the Z-center position in the **Realtime** offline menu is near 0V for most of the scan (try to keep it within +/- 20V). A 1:4 Aspect Ratio captures the image faster.
- Go to **Offline** and **Planefit** and/or **Flatten** the image if necessary.
- Use the histogram in **Bearing** to perform an area depth measurement by determining the relative depth between the histogram cursors.

Figure 21.0a Baring/Depth Analysis Screen



If the measurement is not 200nm + 1nm, calculate the new sensitivity by the following formula:

$$\text{New Sensitivity} = \frac{\text{Old Sensitivity} \times \text{Actual Depth (200nm)}}{\text{Measured Depth}}$$

Input the new sensitivity into the **Z sensitivity** parameter in the **Microscope > Calibrate > Z** menu, then repeat this procedure until the scanner is calibrated.

---

## Calibration

---